

Contents

1	Instructions	4
1.1	General safety instructions	4
1.2	Manufacturer liability	5
1.3	Appliance purpose	5
1.4	Disposal	5
1.5	Identification plate	6
1.6	This user manual	6
1.7	How to read the user manual	6
2	Description	7
2.1	General Description	7
2.2	Control panel	7
2.3	Other parts	8
2.4	Available accessories	9
3	Use	10
3.1	Instructions	10
3.2	First use	10
3.3	Using the accessories	11
3.4	Cooking advice	13
4	Cleaning and maintenance	15
4.1	Instructions	15
4.2	Cleaning the surfaces	15
4.3	Ordinary daily cleaning	15
4.4	Food stains or residues	15
4.5	Removing the door	15
4.6	Cleaning the door glazing	16
4.7	Removing the internal glass panels	16
4.8	Cleaning the inside of the oven	17
4.9	Vapour Clean: assisted oven cleaning (on some models only)	18
4.10	Extraordinary maintenance	19
5	Installation	20
5.1	Electrical connection	20
5.2	Cable replacement	20
5.3	Positioning	21

We advise you to read this manual carefully, which contains all the instructions for maintaining the appliance's aesthetic and functional qualities.

For further information on the product: www.smeg.com



Instructions

1 Instructions

1.1 General safety instructions

Risk of personal injury

- During use the appliance and its accessible parts become very hot.
- Never touch the heating elements during use.
- Keep children under eight years of age at a safe distance if they are not constantly supervised.
- Children must never play with the appliance.
- Never rest metallic objects such as knives, forks, spoons and lids on the appliance during use.
- Switch the appliance off immediately after use.
- Never try to put out a fire or flames with water: turn off the appliance and smother the flames with a fire blanket or other appropriate cover.
- The appliance must never be cleaned by unsupervised children.
- Have qualified personnel carry out installation and assistance interventions according to the standards in force.
- Do not modify this appliance.

- Do not insert pointed metal objects (cutlery or utensils) into the slots in the appliance.
- Do not try to repair the appliance yourself or without the intervention of a qualified technician.
- If the power supply cable is damaged, contact technical support immediately and they will replace it.

Risk of damaging the appliance

- Do not use abrasive or corrosive detergents on glass parts (e.g. powder products, stain removers and metallic sponges).
- Use wooden or plastic utensils.
- Do not seat on the appliance.
- Do not use steam jets for cleaning the appliance.
- Do not obstruct ventilation openings and heat dispersal slots.
- Never leave the appliance unattended during cooking operations where fats or oils could be released.
- Never leave objects on the cooking surface.
- Do not use the appliance to heat rooms for any reason.



For this appliance

- Ensure that the appliance is switched off before replacing the bulb.
- Do not rest any weight or sit on the open door of the appliance.
- Take care that no objects are stuck in the doors.

1.2 Manufacturer liability

The manufacturer declines all liability for damage to persons or property caused by:

- use of the appliance other than the one envisaged;
- non-observance of the user manual provisions;
- tampering with any part of the appliance;
- use of non-original spare parts.

1.3 Appliance purpose

- This appliance is intended for cooking food in the home environment. Every other use is considered improper.
- This appliance must not be used by people (including children) of reduced physical and mental capacity, or lacking in experience in the use of electrical appliances, unless they are supervised or instructed by adults who are responsible for their safety.
- The appliance is not designed to operate with external timers or with remote-control systems.

1.4 Disposal



This appliance must be disposed of separately from other waste (Directives 2002/95/EC, 2002/96/EC, 2003/108/EC). The appliance does not contain substances in quantities sufficient to be considered hazardous to health and the environment, in accordance with current European directives.

To dispose of the appliance:

- Cut the power supply cable and remove it along with the plug.



Power voltage

Danger of electrocution

- Disconnect the main power supply.
- Disconnect the power cable from the electrical system.
- Consign the appliance to the appropriate selective collection centres for electrical and electronic equipment waste, or deliver it back to the retailer when purchasing an equivalent product, on a one for one basis.



Instructions

Our appliances are packed in non-polluting and recyclable materials.

- Consign the packing materials to the appropriate selective collection centres.



Plastic packaging Danger of suffocation

- Do not leave the packaging or any part of it unattended.
- Do not let children play with the packaging plastic bags.

1.5 Identification plate

The identification plate bears the technical data, serial number and brand name of the appliance. Do not remove the identification plate for any reason.

1.6 This user manual

This user manual is an integral part of the appliance and must therefore be kept in its entirety and in an accessible place for the whole working life of the appliance.

Read this user manual carefully before using the appliance.

1.7 How to read the user manual

This user manual uses the following reading conventions:

Instructions



General information on this user manual, on safety and final disposal.

Description



Description of the appliance and its accessories.

Use



Information on the use of the appliance and its accessories, cooking advice.

Cleaning and maintenance



Information for proper cleaning and maintenance of the appliance.

Installation



Information for the authorised persons: installation, operation and inspection.



Safety instructions



Information



Advice

1. Use instruction sequence.

- Single use instruction.



2 Description

2.1 General Description

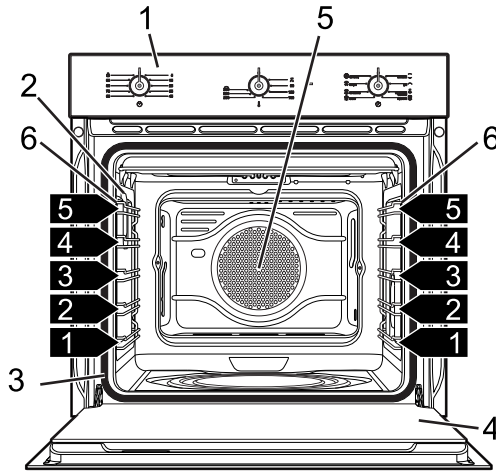

1 Control panel

2 Oven light

3 Seal

4 Door

5 Fan

6 Rack/tray support frames

1,2,3,... Frame shelf

2.2 Control panel

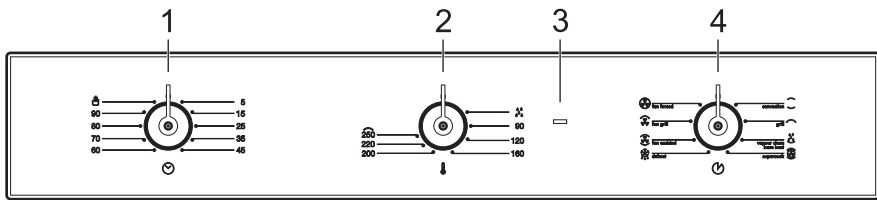

Timer knob (1)

It allows you to use the timer or to perform manual cooking. For timed cooking, turn the knob clockwise to the required time. The oven will stop cooking when time expires.

For manual cooking, turn the knob anti-clockwise to the hand symbol.

Temperature knob (2)

This knob allows you to select the cooking temperature and the Vapour Clean temperature (on some models only).

Turn the knob clockwise to the required value, between the minimum and maximum settings.



Description

Thermostat indicator light (3)

When this indicator light comes on, the oven is heating up. When the light goes out, the preset temperature has been reached. When the light flashes at regular intervals, the temperature inside the oven is being kept constantly at the set level.

Function knob (4)

The oven's various functions are suitable for different cooking modes. After selecting the required function, set the cooking temperature using the temperature knob.

2.3 Other parts

Oven shelves

The oven features shelves for positioning trays and racks at different heights. The insertion heights are indicated from the bottom upwards (see 2.1 General Description).

Cooling fan

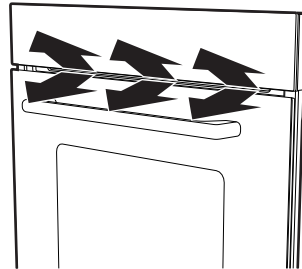

The fan cools the oven and comes into operation during cooking.

The fan causes a steady outflow of air from above the door which may continue for a brief period of time even after the appliance has been turned off.

Internal light

The oven light comes on when the door is opened or any function is selected, except for **P**.



2.4 Available accessories

Rack

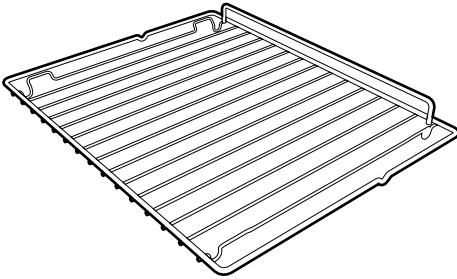

useful for holding cooking containers.

Tray rack

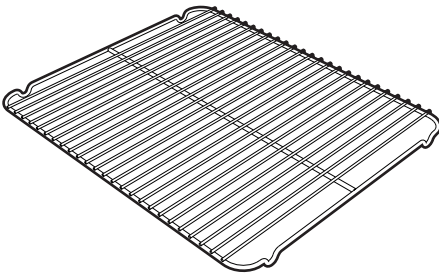

to be placed over the top of the oven tray; for cooking foods which may drip.

Oven tray

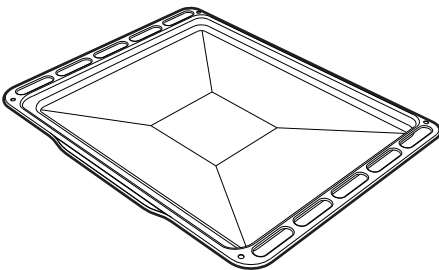

useful for collecting fat from foods placed on the rack above.

Deep tray

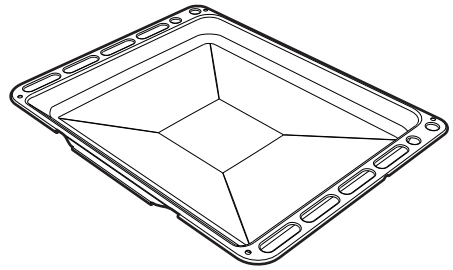

useful for collecting fat from foods placed on the rack above and for cooking pies, pizzas and baked desserts.

Handle for racks and trays

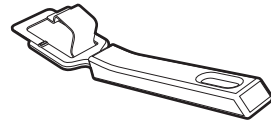

Useful for handling hot racks and trays.

i Some models are not provided with all accessories.

i The oven accessories intended to come into contact with food are made of materials that comply with the provisions of current legislation.

i Original and optional accessories can be requested to Authorised Assistance Centres. Use only original accessories supplied by the manufacturer.



3 Use

3.1 Instructions



High temperature inside the oven during use
Danger of burns

- Keep the oven door closed during cooking.
- Protect your hands using heat resistant gloves when moving food inside the oven.
- Do not touch the heating elements inside the oven.
- Do not pour water directly on very hot trays.
- Young children should be supervised to ensure that they do not play with the appliance.
- If you need to move food or at the end of cooking, open the door 5 cm for a few seconds, let the steam come out, then open it fully.
- During use the appliance becomes hot. Care should be taken to avoid touching heating elements inside the oven.
- Accessible parts will become hot when in use. To avoid burns young children should be kept away.



High temperature inside the oven during use
Danger of fire or explosion

- Do not spray any spray products near the oven.
- Do not use or leave flammable materials near the oven.
- Do not use plastic kitchenware or containers when cooking food.
- Do not put sealed tins or containers in the oven.
- Do not leave the oven unattended during cooking operations where fats or oils could be released.
- Remove from the oven compartment all trays and racks not used during cooking.



Improper use
Risk of damage to enamelled surfaces

- Do not cover the bottom of the oven with aluminium or tin foil sheets.
- If you wish to use greaseproof paper, place it so that it will not interfere with the hot air circulation inside the oven.
- Do not place pans or trays directly on the bottom of the cooking compartment.
- Do not pour water directly on very hot trays.

3.2 First use

1. Remove any protective film from the outside or inside of the appliance, including accessories.
2. Remove any labels (apart from the technical data plate) from trays, dripping pans and the cooking compartment.



3. Remove and wash all the appliance accessories (see 4 Cleaning and maintenance).
4. Heat the empty oven at the maximum temperature to burn off any residues left by the manufacturing process.

3.3 Using the accessories

Racks and trays

Racks and trays have to be inserted into the side guides until they come to a complete stop.

- The mechanical safety locks that prevent the rack from being taken out accidentally have to face downwards and towards the oven back.

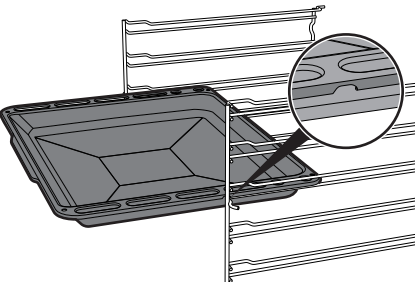
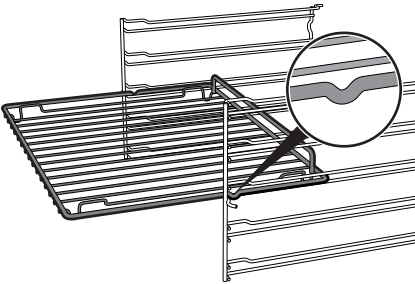

Gently insert racks and trays into the oven until they come to a stop.



Clean the trays before using them for the first time to remove any residues left by the manufacturing process.

Tray rack

The tray rack has to be inserted into the tray. In this way fat can be collected separately from the food which is being cooked.

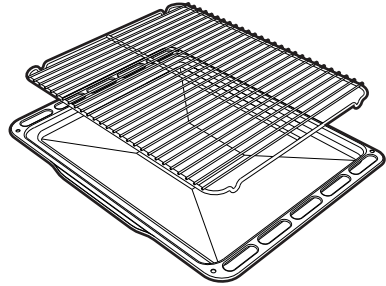

Functions list



Static (convection)

As the heat comes from above and below at the same time, this system is particularly suitable for certain types of food. Traditional cooking, also known as static cooking, is suitable for cooking just one dish at a time. Perfect for all types of roasts, bread and cakes and in any case particularly suitable for fatty meats such as goose and duck.



Use



Grill

The heat coming from the grill element gives perfect grilling results above all for thin and medium thickness meat and in combination with the rotisserie (where present) gives the food an even browning at the end of cooking. Perfect for sausages, ribs and bacon. This function enables large quantities of food, particularly meat, to be grilled evenly.



Bottom (base heat)

The heat coming just from the bottom allows you to complete the cooking of foods that require a higher bottom temperature, without affecting their browning. Perfect for cakes, pies, tarts and pizzas.



Turbo (supercook)

The combination of fan-assisted cooking and traditional cooking allows different foods to be cooked on several levels extremely quickly and efficiently, without odours and flavours mingling. Perfect for large volumes that call for intense cooking.



Defrosting (defrost)

Rapid defrosting is helped by switching on the fan provided and the top heating element that ensure uniform distribution of low temperature air inside the oven.



Fan-assisted static (fan assisted)

The operation of the fan, combined with traditional cooking, ensures uniform cooking even with complex recipes. Perfect for biscuits and cakes, even when simultaneously cooked on several levels. (For multiple-level cooking, we recommend using the 2nd and 4th shelves.)



Fan-assisted grill (fan grill)

The air produced by the fan softens the strong heatwave generated by the grill, grilling perfectly even very thick foods. Perfect for large cuts of meat (e.g. shin of pork).



Fan-assisted circular (fan forced)

The combination of the fan and the circular element (incorporated in the rear of the oven) allows you to cook different foods on several levels, as long as they need the same temperatures and same type of cooking. Hot air circulation ensures instant and uniform distribution of heat. It will be possible, for instance, to cook fish, vegetables and biscuits simultaneously (on different levels) without mixing odours and flavours.



Vapour Clean

This function makes cleaning easier using the steam produced by a little quantity of water poured onto the appropriate drawing placed on the bottom.



3.4 Cooking advice

General advice

- Use a fan-assisted function to achieve uniform cooking at several levels.
- It is not possible to shorten cooking times by increasing the temperature (the food could be overcooked on the outside and undercooked on the inside).

Advice for cooking meat

- Cooking times vary according to the thickness and quality of the food and to consumer taste.
- Use a meat thermometer when roasting meat, or simply press on the roast with a spoon. If it is hard, it is ready; if not, it needs another few minutes cooking.

Advice for cooking with the Grill and the Fan-assisted grill

- Meat can be grilled even when it is put into the cold oven or into the preheated oven if you wish to change the effect of the cooking.
- With the Fan-assisted grill function, we recommend that you preheat the oven before grilling.
- We recommend placing the food at the centre of the rack.
- With the Grill function, we recommend that you turn the temperature knob to the maximum value near the  symbol to optimise cooking.

Advice for cooking desserts and biscuits

- Use dark metal moulds: they help to absorb the heat better.
- The temperature and the cooking time depend on the quality and consistency

of the dough.

- To check whether the dessert is cooked right through: at the end of the cooking time, put a toothpick into the highest point of the dessert. If the dough does not stick to the toothpick, the dessert is cooked.
- If the dessert collapses when it comes out of the oven, on the next occasion reduce the set temperature by about 10°C, selecting a longer cooking time if necessary.

Advice for defrosting and proving

- Place frozen foods without their packaging in a lidless container on the first shelf of the oven.
- Avoid overlapping the food.
- To defrost meat, use the rack placed on the second level and a tray on the first level. In this way, the liquid from the defrosting food drains away from the food.
- The most delicate parts can be covered with aluminium foil.
- For successful proving, a container of water should be placed in the bottom of the oven.

To save energy

- Stop cooking a few minutes before the time normally used. Cooking will continue for the remaining minutes with the heat which has accumulated inside the oven.
- Reduce any opening of the door to a minimum to avoid heat dispersal.
- Keep the inside of the appliance clean at all times.



Use

Cooking information table

Food	Weight (Kg)	Function	Runner position from the bottom	Temperature (°C)	Time (minutes)	
Lasagne	3 - 4	Static	1	220 - 230	45 - 50	
Pasta bake	3 - 4	Static	1	220 - 230	45 - 50	
Roast veal	2	Turbo	2	180 - 190	90 - 100	
Pork	2	Turbo	2	180 - 190	70 - 80	
Sausages	1.5	Fan with grill	4	250	15	
Roast beef	1	Turbo	2	200	40 - 45	
Roast rabbit	1.5	Circulaire	2	180 - 190	70 - 80	
Turkey breast	3	Turbo	2	180 - 190	110 - 120	
Roast pork neck	2 - 3	Turbo	2	180 - 190	170 - 180	
Roast chicken	1.2	Turbo	2	180 - 190	65 - 70	
					1st surface	2nd surface
Pork chops	1.5	Fan with grill	4	250	15	5
Spare ribs	1.5	Fan with grill	4	250	10	10
Bacon	0.7	Grill	5	250	7	8
Pork fillet	1.5	Fan with grill	4	250	10	5
Beef fillet	1	Grill	5	250	10	7
Salmon trout	1.2	Turbo	2	150 - 160	35 - 40	
Monkfish	1.5	Turbo	2	160	60 - 65	
Turbot	1.5	Turbo	2	160	45 - 50	
Pizza	1	Turbo	2	250	8 - 9	
Bread	1	Circulaire	2	190 - 200	25 - 30	
Focaccia	1	Turbo	2	180 - 190	20 - 25	
Sponge cake	1	Circulaire	2	160	55 - 60	
Jam tart	1	Circulaire	2	160	35 - 40	
Ricotta cake	1	Circulaire	2	160 - 170	55 - 60	
Jam tarts	1	Turbo	2	160	20 - 25	
Paradise cake	1.2	Circulaire	2	160	55 - 60	
Cream puffs	1.2	Turbo	2	180	80 - 90	
Light sponge cake	1	Circulaire	2	150 - 160	55 - 60	
Rice pudding	1	Turbo	2	160	55 - 60	
Brioches	0.6	Circulaire	2	160	30 - 35	



4 Cleaning and maintenance

4.1 Instructions



Improper use
Risk of damage to surfaces

- Do not use a steam cleaner to clean the appliance.
- Do not use cleaning products containing chlorine, ammonia or bleach on steel parts or parts with metallic finishes on the surface (e.g. anodizing, nickel- or chromium-plating).
- Do not use abrasive or corrosive detergents on glass parts (e.g. powder products, stain removers and metallic sponges).
- Do not use harsh abrasive cleaners or sharp metal scrapers to clean the oven glass door since they can scratch the surface, which may result in shattering of the glass.
- Do not use rough or abrasive materials or sharp metal scrapers.

4.2 Cleaning the surfaces

To keep the oven surfaces in good condition, they should be cleaned regularly after use. Let them cool first.

4.3 Ordinary daily cleaning

Always use only specific products that do not contain abrasives or chlorine-based acids.

Pour the product onto a damp cloth and wipe the surface, rinse thoroughly and dry with a soft cloth or a microfibre cloth.

4.4 Food stains or residues

Do not use metallic sponges or sharp scrapers as they will damage the surfaces.

Use ordinary non-abrasive products with the aid of wooden or plastic utensils if necessary. Rinse thoroughly and dry with a soft cloth or a microfibre cloth.

Do not allow residues of sugary foods (such as jam) to set inside the oven. If left to set for too long, they might damage the enamel lining of the oven.

4.5 Removing the door

For easier cleaning, the door can be removed and placed on a canvas.

To remove the door proceed as follows:

1. Open the door completely and insert two pins into the holes on the hinges indicated in the figure.

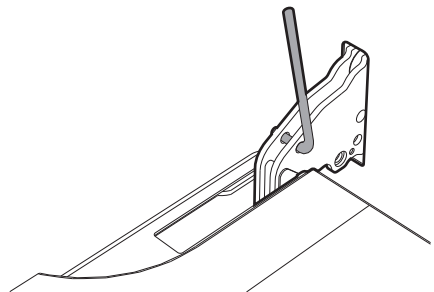
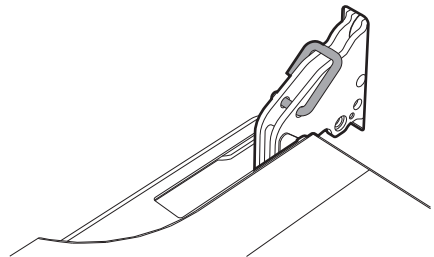



Cleaning and maintenance

2. Grasp the door on both sides with both hands, lift it forming an angle of around 30° and remove it.

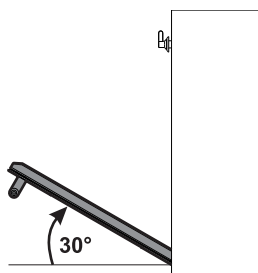

3. To reassemble the door, put the hinges in the relevant slots in the oven, making sure that grooved sections A are resting completely in the slots. Lower the door and once it is in place remove the pins from the holes in the hinges.

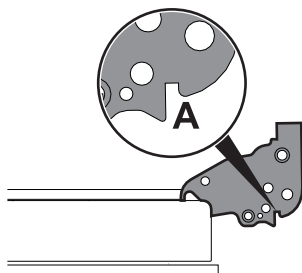

4.6 Cleaning the door glazing

The glass in the door should always be kept thoroughly clean. Use absorbent kitchen roll. In case of stubborn dirt, wash with a damp sponge and an ordinary detergent.



We recommend the use of cleaning products distributed by the manufacturer.

4.7 Removing the internal glass panels

For easier cleaning the door internal glass panels can be disassembled.

1. Remove the internal glass panel by pulling the rear part gently upwards, following the movement indicated by the arrows (1).
2. Then, pull the front part upwards (2). In this way, the 4 pins attached to the glass detach from their housings in the oven door.

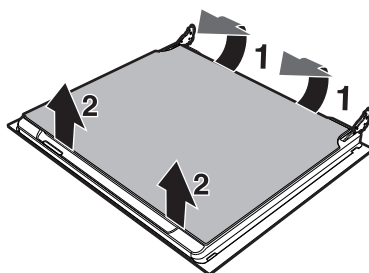

3. Clean the external glass panel and the panels previously removed. Use absorbent kitchen roll. In case of stubborn dirt, wash with a damp sponge and neutral detergent.

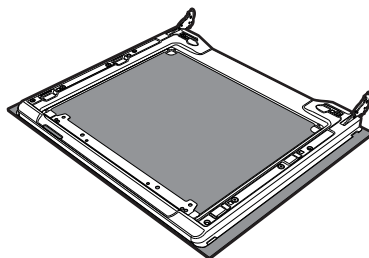

4. Replace the panels in the reverse order in which they were removed.



5. Reposition the internal glass panel. Take care to centre and insert the 4 pins into their housings in the oven door by applying slight pressure.

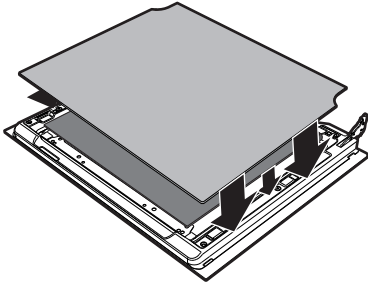

4.8 Cleaning the inside of the oven

For the best oven upkeep, clean it regularly after having allowed it to cool.

Take out all removable parts.



Clean the oven racks with warm water and non-abrasive detergent. Carefully rinse and dry the damp parts.



The oven should be operated at the maximum temperature for about 15-20 minutes after the use of specific products, to burn off the residues left inside the oven.



For easier cleaning, remove the door.

Removing racks/trays support frames

Removing the guide frames enables the sides to be cleaned more easily. This operation should be performed each time the automatic cleaning cycle is used (only on some models).

To remove the guide frames. Pull the frame towards the inside of the oven to unhook it from its groove **A**, then slide it out of the seats **B** at the back.

When cleaning is complete, repeat the above procedures to put the guide frames back in.

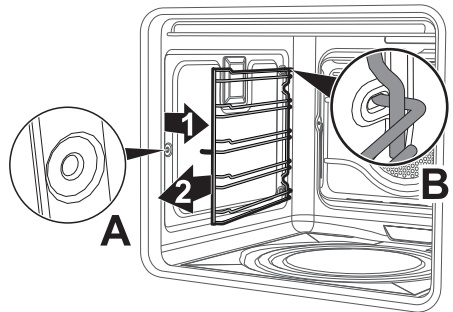



Cleaning and maintenance

4.9 Vapour Clean: assisted oven cleaning (on some models only)



Vapour Clean is an assisted cleaning procedure which facilitates the removal of dirt. Thanks to this process, it is possible to clean the inside of the oven very easily. The dirt residues are softened by the heat and water vapour for easier removal afterwards.



Improper use Risk of damage to surfaces

- Remove from the inside of the oven any food residues or large spills from previous cooking operations.
- Carry out assisted oven cleaning operations only when the oven is cold.

Preliminary operations

Before starting the Vapour Clean cycle:

- Completely remove all accessories from inside the oven. The roof lining can be left inside the oven.
- Pour approx. 40 cc of water onto the floor of the oven. Make sure it does not overflow out of the cavity.

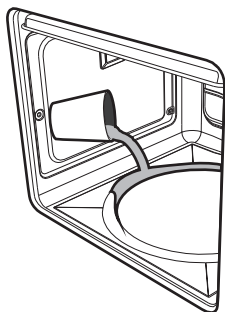

- Spray a water and washing up liquid solution inside the oven using a spray nozzle. Direct the spray against the side walls, upwards, downwards and towards the deflector.

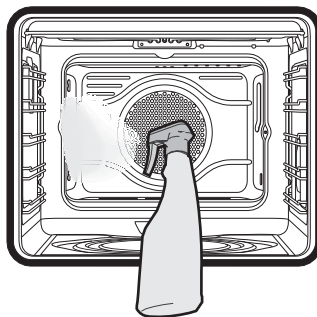

- Close the door.



We recommend spraying approx. 20 times at the most.

Vapour Clean setting

1. Turn the function knob and the temperature knob to the  symbol.
2. Set a cooking time of 18 minutes using the timer knob.
3. At the end of the cooking time, the timer will switch the oven heating elements off and the buzzer will start to sound.

End of the Vapour Clean cycle

4. Open the door and wipe away the less stubborn dirt with a microfibre cloth.
5. Use an anti-scratch sponge with brass filaments on tougher encrustations.
6. In case of grease residues use specific oven cleaning products.
7. Remove the water left inside the oven.



- For improved hygiene and to avoid food being affected by any unpleasant odours, we recommend that the oven is dried using a fan-assisted function at 160°C for approximately 10 minutes.



We recommend that you use rubber gloves for these operations.



For easier manual cleaning of the parts difficult to reach, we recommend that you remove the door.

4.10 Extraordinary maintenance



Live parts
Danger of electrocution

- Ensure the appliance is switched off before replacing the lamp to avoid the possibility of electric shock.

Replacing the internal light bulb

- Completely remove all accessories from inside the oven.
- Remove the racks/trays support frames.
- Remove the bulb cover using a tool (e.g. a screwdriver).

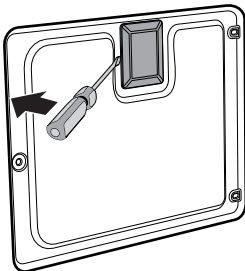

- Slide out and remove the lamp.

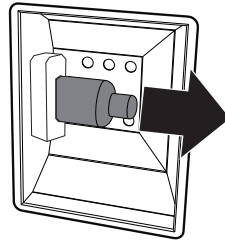

Do not touch the halogen lamp directly with your fingers, but wrap it in an insulating material.

- Replace the lamp with one of the same type (40W).
- Refit the cover correctly, so that the moulded part of the glass is facing the door.
- Press the cover completely down so that it attaches perfectly to the bulb support.

Removing the door seal

To permit thorough cleaning of the oven, the door seal may be removed. There are fasteners on all four sides to attach it to the edge of the oven. Pull the 4 edges of the seal outwards to detach the fasteners.

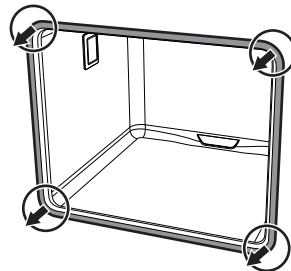



Installation

5 Installation

5.1 Electrical connection



Power voltage
Danger of electrocution

- Have the electrical connection performed by authorised technical personnel.
- The appliance must be connected to earth in compliance with electrical system safety standards.
- Disconnect the main power supply.

General information

Check the grid characteristics against the data indicated on the plate.

The identification plate bearing the technical data, serial number and brand name is visibly positioned on the appliance.

Do not remove this plate for any reason.

The appliance works at 220-240 V~.

Use a H05V2V2-F type three core cable (3 x 1.5 mm² cable, referring to the cross section of the internal conductor).

Perform the ground connection using a wire that is 20 mm longer than the other wires.

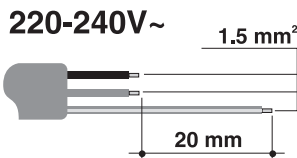

Fixed connection

Fit the power line with an omnipolar circuit breaker in compliance with installation regulations.

The circuit breaker should be located near the appliance and in an easily reachable position.

Connection with plug and socket

Make sure that the plug and socket are of the same type.

Avoid use of adapters and shunts as these could cause overheating and a risk of burns.

5.2 Cable replacement



Power voltage
Danger of electrocution

- Disconnect the main power supply.

1. Unscrew the rear casing screws and remove the casing to access the terminal board.

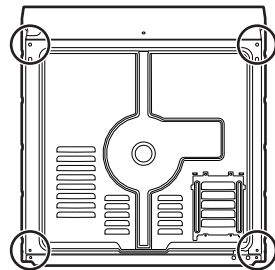

2. Replace the cable.
3. Make sure that the cables (for the oven or any hob) follow the best route in order to avoid any contact with the appliance.



5.3 Positioning



**Heavy appliance
Danger of crush injuries**

- Place the appliance into the piece of furniture with the aid of a second person.



**Pressure on the open door
Risk of damages to the appliance**

- When positioning the appliance during installation, do not use the door handle to lift up or move this appliance.
- Never use the oven door to lever the appliance into place when fitting.
- Avoid exerting too much pressure on the oven door when open.



**Heat production during appliance operation
Risk of fire**

- Check that the piece of furniture material is heat resistant.
- Check that the piece of furniture has the required slots.

Fastening bushings

Remove the bushing covers inserted on the oven front.

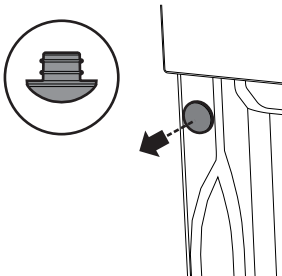

Mount the appliance into the recess.
Secure the appliance to the piece of furniture using screws.

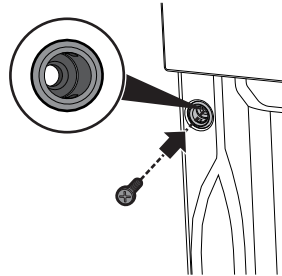

Cover the bushings with the covers removed previously.

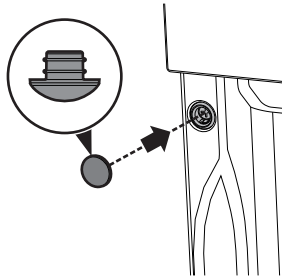

Appliance overall dimensions (mm)

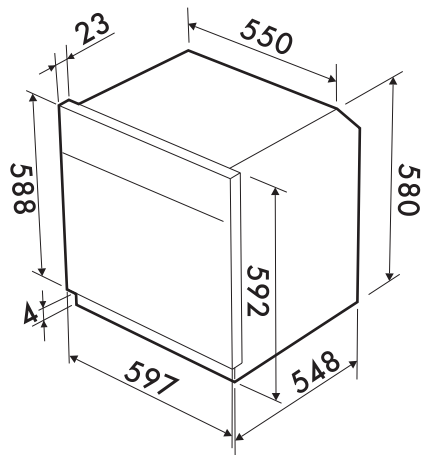



Installation

Mounting under worktops (mm)

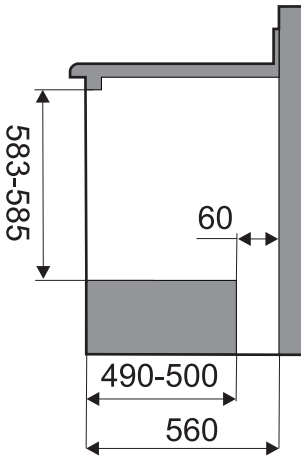
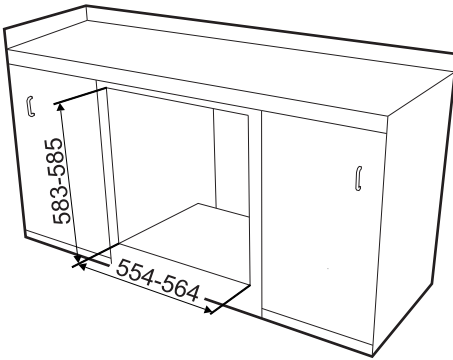

Mounting into a column (mm)

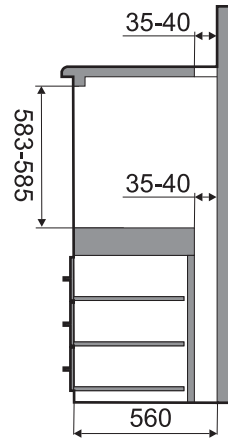
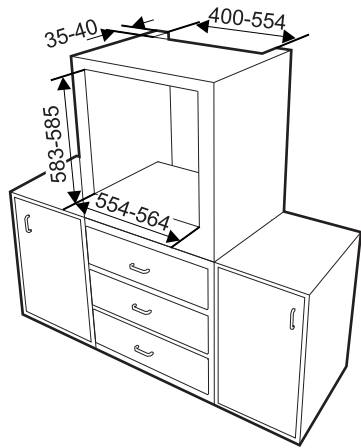

Make sure that the piece of furniture rear/bottom part has an opening of approx. 60 mm.



Make sure that the piece of furniture top/rear part has an opening approx. 35-40 mm deep.



914775158/F