

Contents

1	Instructions	76
1.1	General safety instructions	76
1.2	Appliance purpose	79
1.3	Manufacturer liability	79
1.4	This user manual	79
1.5	Identification plate	79
1.6	Disposal	79
1.7	How to read the user manual	80
2	Description	81
2.1	General Description	81
2.2	Control panel	81
2.3	Other parts	82
2.4	Available accessories	83
3	Use	84
3.1	Instructions	84
3.2	First use	84
3.3	Using the accessories	85
3.4	Using the oven	86
3.5	Cooking advice	95
3.6	Special functions	96
3.7	Preset programs	106
3.8	Personal recipes	116
3.9	Settings	122
4	Cleaning and maintenance	128
4.1	Instructions	128
4.2	Cleaning the surfaces	128
4.3	Cleaning the door	129
4.4	Cleaning the oven	131
4.5	Pyrolytic	132
4.6	Extraordinary maintenance	136
5	Installation	138
5.1	Electrical connection	138
5.2	Instructions for the installer	139
5.3	Cable replacement	139
5.4	Positioning	140

TRANSLATION OF THE ORIGINAL INSTRUCTIONS

We advise you to read this manual carefully, which contains all the instructions for maintaining the appliance's aesthetic and functional qualities.

For further information on the product: www.smeg.com



1 Instructions

1.1 General safety instructions

Risk of personal injury

- During use the appliance and its accessible parts become very hot. Never touch the heating elements during use.
- Protect your hands by wearing oven gloves when handling food inside the oven cavity.
- Never try to put out a fire or flames with water: turn off the appliance and smother the flames with a fire blanket or other appropriate cover.
- This appliance may be used by children aged at least 8 and by people of reduced physical, sensory or mental capacity, or lacking in experience in the use of electrical appliances, as long they are supervised or instructed by adults who are responsible for their safety.
- Children must not be allowed to play with the appliance.
- Keep children under eight years of age at a safe distance if they are not constantly supervised.
- Do not allow children younger than 8 years old to come near the appliance when in operation.
- Cleaning and maintenance must not be carried out by unsupervised children.
- The cooking process must always be monitored. Short cooking processes must be monitored continuously.
- Never leave the appliance unattended during cooking operations in which fats or oils could be released that could overheat and catch fire. Be very careful.
- Do not pour water directly onto very hot trays.
- Keep the oven door closed during cooking.
- If you need to move food or at the end of cooking, open the door 5 cm for a few seconds, let the steam come out, then open it fully.
- Do not insert pointed metal objects (cutlery or utensils) into the slots in the appliance.
- Switch the appliance off immediately after use.



- DO NOT USE OR STORE FLAMMABLE MATERIALS NEAR THE APPLIANCE.
- NEVER USE AEROSOL CANS NEAR THE APPLIANCE WHILE IT IS IN OPERATION.
- DO NOT MODIFY THIS APPLIANCE.
- Have authorised persons carry out installation and assistance interventions according to the standards in force.
- Do not try to repair the appliance yourself or without the intervention of authorised persons.
- Do not pull the cable to remove the plug.
- Switch off the burners or the electric hot plates of the cooktop, if installed above the appliance, during the pyrolytic process (where available).
- Do not use cleaning products containing chlorine, ammonia or bleach on steel parts or parts with metallic surface finishes (e.g. anodizing, nickel- or chromium-plating).
- Racks and trays must be inserted as far as they will go into the side guides. The mechanical safety locks that prevent them from being removed must face downwards and towards the back of the oven cavity.

Risk of damaging the appliance

- Do not use abrasive or corrosive detergents (e.g. scouring powders, stain removers and metallic sponges) on glass parts. Use wooden or plastic utensils.
- Do not use rough or abrasive materials or sharp metal scrapers.
- Do not seat on the appliance.
- Do not use steam jets to clean the appliance.
- Do not spray any spray products near the appliance.
- Do not obstruct ventilation openings and heat dispersal slots.
- Never leave objects on the cooking surface.
- DO NOT USE THE APPLIANCE TO HEAT ROOMS FOR ANY REASON.



Instructions

- Do not use plastic kitchenware or containers when cooking food.
- Do not put sealed tins or containers in the oven.
- Remove all trays and racks which are not required during cooking.
- Do not cover the bottom of the oven cavity with aluminium or tin foil sheets.
- Do not place pans or trays directly on the bottom of the oven cavity.
- If you wish to use greaseproof paper, place it so that it will not interfere with the hot air circulation inside the oven.
- Do not use the open door to rest pans or trays on the internal glass panel.
- Never use the oven door to lever the appliance into place when fitting.
- Avoid exerting too much pressure on the oven door when open.
- Do not use the handle to lift or move the appliance.
- This appliance can be used up to a maximum altitude of 4000 metres above sea level.

Installation and maintenance

- THIS APPLIANCE **MUST NOT BE INSTALLED** IN BOATS OR CARAVANS.
- The appliance must not be installed on a stand.
- Position the appliance into the cabinet cutout with the help of a second person.
- To prevent overheating, the appliance must not be installed behind a decorative door or a panel.
- Have authorised persons carry out installation and assistance interventions according to the standards in force.
- Have the electrical connection performed by authorised persons.
- The appliance must be connected to earth in compliance with electrical system safety standards.
- Use cables withstanding a temperature of at least 90 °C.
- The tightening torque of the screws of the terminal supply wires must be 1.5 - 2 Nm.



- If the power supply cable is damaged, contact technical support immediately and they will replace it.
- Before carrying out any work on the appliance (installation, maintenance, positioning or moving), wear personal protective equipment.
- Before carrying out any work on the appliance, disconnect the mains power supply.

For this appliance

- Ensure that the appliance is switched off before replacing the bulb.
- Do not rest any weight or sit on the open door of the appliance.
- Take care that no objects are stuck in the doors.
- Do not install / use the appliance outdoors.

1.2 Appliance purpose

- This appliance is intended for cooking food in the home environment. Every other use is considered improper.
- The appliance is not designed to operate with external timers or with remote-control systems.

1.3 Manufacturer liability

The manufacturer declines all liability for damage to persons or property caused by:

- use of the appliance other than the one envisaged;
- failure to comply with the instructions in the user manual;
- tampering with any part of the appliance;
- the use of non-original spare parts.

1.4 This user manual

This user manual is an integral part of the appliance and must therefore be kept in its entirety and in an accessible place for the whole working life of the appliance.

Read this user manual carefully before using the appliance.

1.5 Identification plate

The identification plate bears the technical data, serial number and brand name of the appliance. Do not remove the identification plate for any reason.

1.6 Disposal



This appliance must be disposed of separately from other waste (Directives 2002/95/EC, 2002/96/EC, 2003/108/EC). The appliance does not contain substances in quantities sufficient to be considered hazardous to health and the environment, in accordance with current European directives.



Instructions

To dispose of the appliance:

- Cut the power supply cable and remove it along with the plug.



Power voltage

Danger of electrocution

- Disconnect the mains power supply.
- Unplug the power cable from the socket.
- Deliver the appliance to the appropriate recycling facility for electrical and electronic equipment waste, or deliver it back to the retailer when purchasing an equivalent product, on a one for one basis.

Our appliances are packaged in non-polluting and recyclable materials.

- Deliver the packing materials to the appropriate recycling facility.



Plastic packaging

Danger of suffocation

- Do not leave the packaging or any part of it unattended.
- Do not let children play with the plastic bags.

1.7 How to read the user manual

This user manual uses the following reading conventions:

Instructions



General information on this user manual, on safety and final disposal.

Description



Description of the appliance and its accessories.

Use



Information on the use of the appliance and its accessories, cooking advice.

Cleaning and maintenance



Information for proper cleaning and maintenance of the appliance.

Installation



Information for authorised persons: installation, operation and inspection.



Safety instructions



Information



Advice

1. Sequence of instructions for use.

- Standalone instruction.



2 Description

2.1 General Description

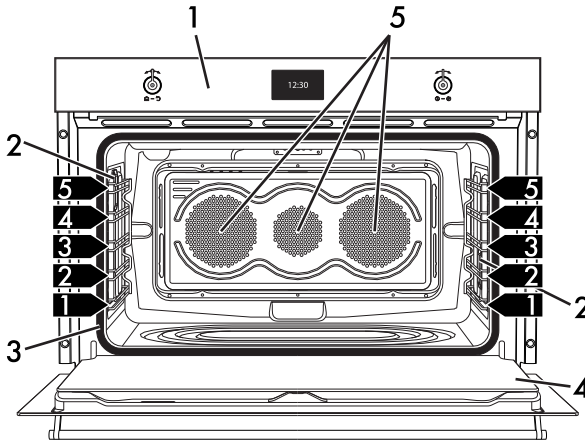

1 Control panel

2 Oven light

3 Seal

4 Door

5 Fan

1,2,3 Frame shelf

2.2 Control panel

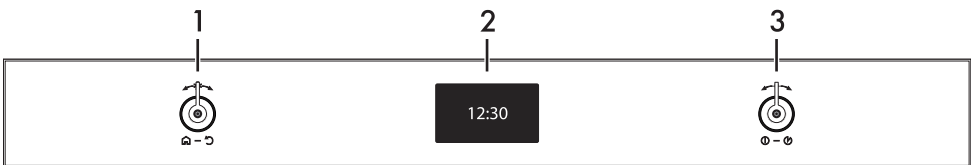

1 Return knob

Using this knob you can return to the appliance's previous menu item. It also allows you to turn the oven light on and off manually.

2 Display

Displays the current time, the cooking parameters, and all the appliance's functions.



Description

3 Control knob —

This knob allows you to turn the appliance on and off and select the various available functions.

Turn the knob right or left to change/select the required item.

Press to confirm.



Keep the knob pressed in for at least 5 seconds to immediately complete any cooking operation.

2.3 Other parts

Shelves

The appliance features shelves to position trays and racks at different heights. The insertion heights are indicated from the bottom upwards (see 2.1 General Description).



Cooling fan

The fan cools the appliance and comes into operation during cooking.

The fan causes a steady outflow of air from above the door which may continue for a brief period of time even after the appliance has been turned off.

Interior lighting

The appliance's interior lighting comes on:

- When the door is opened.
- When any function is started apart from the ECO Pyrolytic  and Pyrolytic  functions.
- When the temperature knob is turned briefly to the right (manual activation/deactivation).



When the door is open, it is not possible to turn off the interior lighting.



2.4 Available accessories

Tray rack

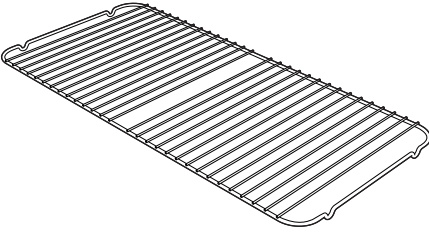

To be placed over the top of the oven tray; for cooking foods which may drip.

Deep tray

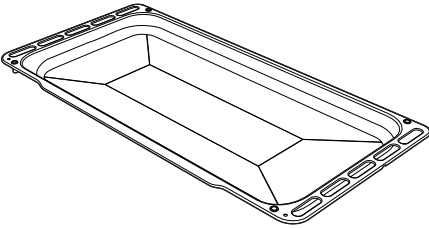

Useful for collecting fat from foods placed on the rack above and for cooking pies, pizzas and baked desserts.

Rack

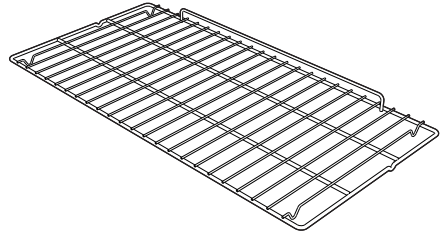

Useful for supporting containers with food during cooking.

i Some models are not provided with all accessories.

i The accessories intended to come into contact with food are made of materials that comply with the provisions of current legislation.

i Supplied and optional accessories can be requested to Authorised Assistance Centres. Use only original accessories supplied by the manufacturer.

EN



3 Use

3.1 Instructions



Improper use

Risk of damage to surfaces

- Do not cover the bottom of the oven cavity with aluminium or tin foil sheets.
- If you wish to use greaseproof paper, place it so that it will not interfere with the hot air circulation inside the oven.
- Do not place pans or trays directly on the bottom of the oven cavity.
- Do not pour water directly onto very hot trays.



High temperature inside the oven during use

Danger of burns

- Keep the oven door closed during cooking.
- Protect your hands by wearing oven gloves when moving food inside the oven.
- Do not touch the heating elements inside the oven.
- Do not pour water directly onto very hot trays.
- Do not allow children to approach the appliance when it is in operation.



High temperature inside the oven during use

Danger of fire or explosion

- Do not spray any spray products near the appliance.
- Do not use or leave flammable materials near the appliance.
- Do not use plastic kitchenware or containers when cooking food.
- Do not put sealed tins or containers in the oven.
- Do not leave the appliance unattended during cooking operations where fats or oils could be released.
- Remove all trays and racks which are not required during cooking.

3.2 First use

1. Remove any protective film from the outside or inside of the appliance, including accessories.
2. Remove any labels (apart from the technical data plate) from the accessories and from the oven cavity.
3. Remove and wash all the appliance accessories (see 4 Cleaning and maintenance).
4. Heat the empty oven at the maximum temperature to burn off any residues left by the manufacturing process.



3.3 Using the accessories

Tray rack

The tray rack has to be inserted into the tray. In this way fat can be collected separately from the food which is being cooked.

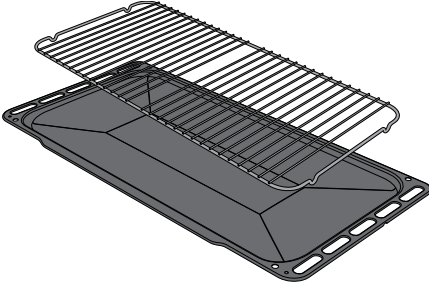

Racks and trays

Racks and trays have to be inserted into the side guides until they come to a complete stop.

The mechanical safety locks that prevent the rack from being removed accidentally must face downwards and towards the back of the oven cavity.

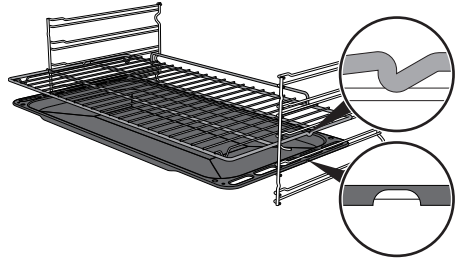

Carefully insert the racks and trays as far as they will go into the oven cavity.



Clean the trays before using them for the first time to remove any residues left by the manufacturing process.



3.4 Using the oven

First use

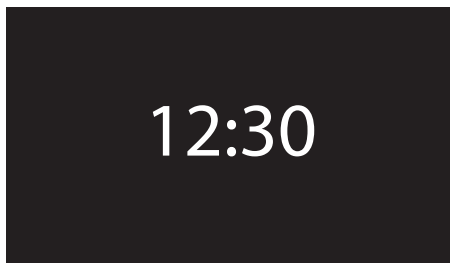

On the first use, or after a power failure, **00:00** will flash on the appliance's display. In order to be able to start any cooking operation, the current time must be set (if the oven is being turned on for the first time, it is also recommended you set the required language).

Press the control knob to enter the settings menu, see "3.9 Settings".



The appliance language is set to "English" by default.



When first connecting or after the power has been cut for a time it will be necessary to wait a few seconds before you can interact with the appliance.

Reactivating the display

If the Eco-Light mode is active (see "Eco-Light" in the "Settings" section), the display will switch off 2 minutes after the appliance was last used.

To reactivate the display when it is off:

- turn or press one of the two knobs on the appliance.

The appliance will emit a series of sounds and the display will switch on after a few seconds. The display shows the current time screen when it is switched on again.



The lamp inside the oven cavity switches on if you turn the return knob to the right or left to reactivate the display.



The main menu will appear on the display if you reactivate the display by pressing the control knob.

menu

cooking functions

special functions

preset programs

personal recipes

settings



Favourites

Press the return knob from the clock screen to display the last preset programs or personal recipes used.



3. Select **YES** if you wish to delete the favourites.



NE

Deleting favourites

If you wish to delete the favourites:

1. Press the return knob from the clock screen to display the last preset programs or personal recipes used.
2. Hold the control knob down for a few seconds.



Cooking functions

1. On the clock screen, press the control knob to access the main menu.
2. Turn the control knob to the right or left to select **cooking functions** from the main menu.
3. Press the control knob to confirm.

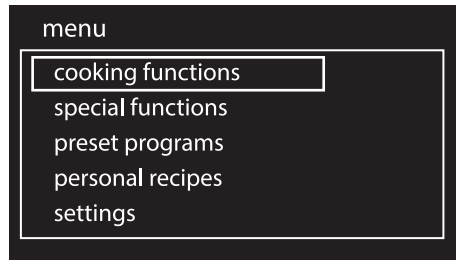



Use

- Turn the control knob to select the required function.
- Press the control knob to confirm the selection.

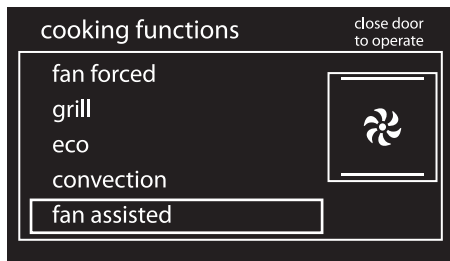

When the preheating stage is over a buzzer will sound to indicate that the food can be placed inside the oven.



Interrupting a function

To interrupt a cooking function:

- Press the return knob.
- Select the required option
- Press the return knob to confirm.

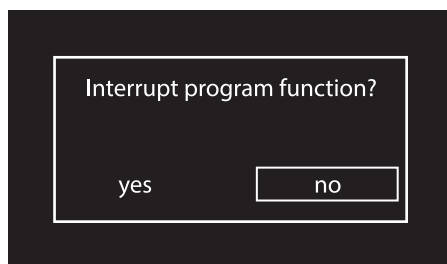

i For safety reasons, it is only possible to set cooking functions when the door is closed.

The appliance will begin preheating. The display will show the selected function, the pre-set temperature, the current time and the progress bar of the temperature reached.

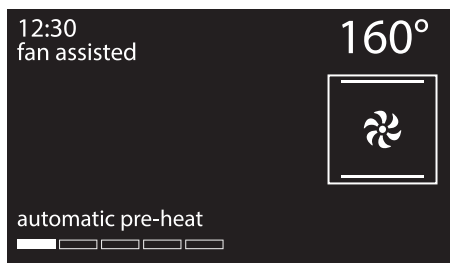

✎ Keep the control knob pressed in for at least 5 seconds to immediately interrupt cooking at any time and return to the main menu.

✎ Turn the control knob to change the preset temperature at any time. Press to confirm or wait 5 seconds.

✎ It is not recommended to put the dish in the oven whilst the oven is warming up.



List of cooking functions

ECO

Eco

This low energy consumption function is particularly suitable for cooking on a single shelf.

Ideal when cooking meat, fish and vegetables. It is not recommended for foods that require proving.

For greater energy savings and to reduce the time required, it is recommended to put foods in the oven cavity without preheating it.



When using the ECO function, avoid opening the oven door during cooking.



When using the ECO function, cooking times (and pre-heating, if used) are longer.

Convection

As the heat comes from above and below at the same time, this system is particularly suitable for certain types of food. Traditional cooking, also known as static cooking, is suitable for cooking just one dish at a time. Perfect for all types of roasts, bread and cakes and in any case particularly suitable for fatty meats such as goose and duck.

Grill

The heat coming from the grill element gives perfect grilling results above all for thin and medium thickness meat and, in combination with the rotisserie (where fitted), gives the food an even browning at the end of cooking. Perfect for sausages, ribs and bacon. This function enables large quantities of food, particularly meat, to be grilled evenly.

Bottom

The heat coming just from the bottom allows you to complete the cooking of foods that require a higher bottom temperature, without affecting their browning. Perfect for cakes, pies, tarts and pizzas.

Fan assisted

The operation of the fan, combined with traditional cooking, ensures consistent cooking even with complex recipes. Perfect for biscuits and cakes, even when cooked simultaneously on several levels. (For multiple-level cooking, we recommend using the 1st and 4th shelves.)



Fan grill

The air produced by the fan softens the strong heatwave generated by the grill, grilling perfectly even very thick foods. Perfect for large cuts of meat (e.g. pork shank).



Baker's function

The combination of the fan with just the bottom heating element allows cooking to be completed more rapidly. This system is recommended for sterilising or for finishing off the cooking of foods which are already well-cooked on the surface, but not inside, which therefore need a little more heat. Perfect for any type of food.



Fan forced

The combination of the fan and the circular heating element (incorporated in the rear of the oven cavity) allows you to cook different foods on several levels, as long as they require the same temperature and type of cooking. Hot air circulation ensures instant and even distribution of heat. It will be possible, for instance, to cook fish, vegetables and biscuits simultaneously (on different levels) without odours and flavours mingling.



Supercook

The combination of fan assisted cooking and traditional cooking allows different foods to be cooked on several levels extremely quickly and efficiently, without odours and flavours mingling. Perfect for large volumes that call for intense cooking. (For multiple-level cooking, we recommend using the 1st and 4th shelves.)



Fan forced + fan grill

The combination of fan-assisted cooking and traditional cooking allows you to cook different foods on several levels extremely quickly and efficiently, without odours and flavours mingling. Perfect for large volumes that call for intense cooking.





Timer during a function

i This function only activates the buzzer, without stopping cooking.

1. Press the control knob during a cooking function.
2. Turn the control knob right or left to set the duration (from 1 minute to 4 hours). After a few seconds, the  symbol stops flashing and the countdown starts.



3. Wait for the buzzer to indicate that the time has finished. The  symbol flashes.

 Turn the knob right or left to select another timer or press the control knob to deactivate the buzzer.

Timed cooking

i Timed cooking is the function which allows a cooking operation to be started and then ended after a specific length of time set by the user.

i Activation of timed cooking cancels any minute minder timer which may previously have been set.

1. After selecting a cooking function and temperature, press the control knob twice.
2. Turn the knob right or left to set the minutes of cooking from 00:01 to 13:00. Keep the knob turned to produce a faster increase or decrease.

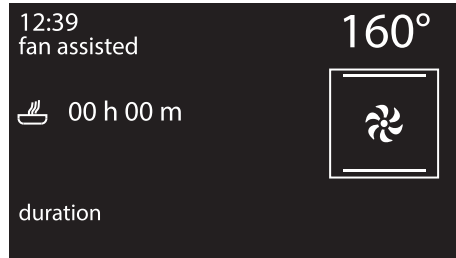



Use

3. A few seconds after the required duration is set, the  symbol stops flashing and timed cooking starts.

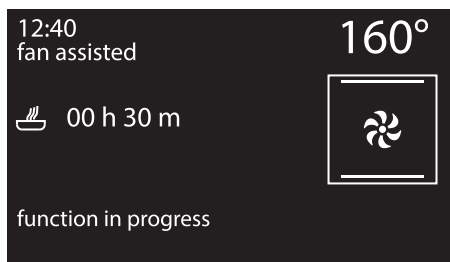

4. At the end of the cooking cycle, “function ended” appears on the display and a buzzer sounds.
5. To turn off the buzzer, press or turn one of the two knobs or open the door.

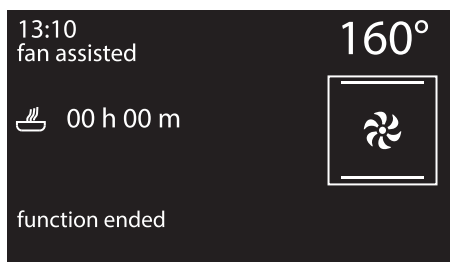

Turn the control knob to add some minutes of cooking time.





To extend the cooking time manually, press the control knob again. The appliance will resume its normal operation with the previously selected cooking settings.



To turn off the appliance see “Interrupting a function”.

Modifying the data set during timed cooking

During operation, it is possible to modify timed cooking duration:

1. When the  symbol is steady and the appliance is cooking, press the control knob. The  symbol starts flashing.
2. Turn the control knob right or left to alter the previously set cooking duration.



Use

- At the end of the cooking cycle, "function ended" appears on the display and a buzzer sounds.
- To turn off the buzzer, press or turn one of the two knobs or open the door.

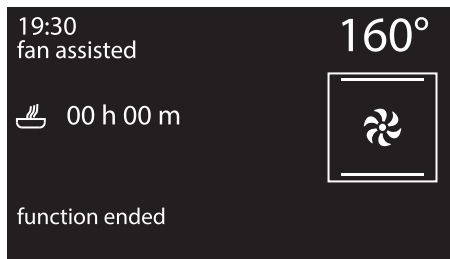







Modifying the data set during programmed cooking



After modifying the cooking duration, the end of cooking time must be re-set.

During operation, it is possible to modify programmed cooking duration:

- When the  and  symbols are lit steadily and the appliance is waiting for cooking to start, press the control knob. The  symbol starts flashing.
- Turn the control knob to alter the previously set cooking time.
- Press the control knob again. The  symbol switches off and  starts flashing. The display shows the end of cooking time.
- Turn the control knob to delay the end of cooking time.
- After a few seconds the  and  symbols stop flashing and programmed cooking restarts its operation with the new settings.



To extend the cooking time manually, press the control knob again. The appliance will resume its normal operation with the previously selected cooking settings.



For safety reasons, it is not possible to set the cooking end time by itself without setting the cooking duration.



If the cooking duration is modified, the end of cooking time is deleted.



3.5 Cooking advice

General advice

- Use a fan assisted function to achieve consistent cooking at several levels.
- It is not possible to shorten cooking times by increasing the temperature (the food could be overcooked on the outside and undercooked on the inside).
- For the same total weight, cooking time will be greater when cooking a whole piece than when it is cut into smaller pieces.

Advice for cooking meat

- Cooking times vary according to the thickness and quality of the food and to consumer taste.
- Use a meat thermometer when roasting meat, or simply press on the roast with a spoon. If it is hard, it is ready; If not, it needs another few minutes cooking.

Advice for cooking with the Grill

- Meat can be grilled even when it is put into the cold oven or into the preheated oven if you wish to change the effect of the cooking.
- With the Fan grill function, we recommend that you preheat the oven cavity before grilling.
- We recommend placing the food at the centre of the rack.

Advice for cooking desserts/pastries and biscuits

- Use dark metal moulds: They help to absorb the heat better.
- The temperature and the cooking time depend on the quality and consistency of the dough.
- When cooking on multiple levels, food should ideally be positioned on the second and fourth shelves; increase the cooking time by a few minutes and only use fan assisted functions.
- To check whether the dessert is cooked right through: At the end of the cooking time, put a toothpick into the highest point of the dessert. If the dough does not stick to the toothpick, the dessert is cooked.
- If the dessert collapses when it comes out of the oven, on the next occasion reduce the set temperature by about 10°C, selecting a longer cooking time if necessary.
- The cooking time for meringues and profiteroles will vary depending on their size.

Advice for defrosting and proving

- Place frozen foods without their packaging in a lidless container on the first shelf of the oven cavity.
- Avoid overlapping the food.



- To defrost meat, use the rack placed on the second level and a tray on the first level. In this way, the liquid from the defrosting food drains away from the food.
- Fruit and bread, if divided into pieces, take the same amount of time to defrost regardless of the quantity and the total weight.
- The most delicate parts can be covered with aluminium foil.
- For successful proving, a container of water should be placed at the bottom of the oven cavity.

To save energy

- Stop cooking a few minutes before the time normally used. Cooking will continue for the remaining minutes with the heat which has accumulated inside the oven.
- Reduce any opening of the door to a minimum to avoid heat dispersal.
- Keep the inside of the appliance clean at all times.
- (Where fitted) When it is not being used, remove the pizza stone from the bottom of the oven cavity.

3.6 Special functions

i Some functions such as the oven off timer, defrost or cleaning functions are grouped in the special functions menu.

1. On the clock screen, press the control knob to access the main menu.
2. Turn the control knob to the right or left to select **special functions** from the main menu.
3. Press the control knob to confirm.

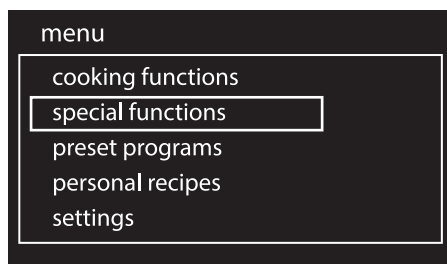

i Certain functions are not available on all models.



List of special functions



Timer

This function sounds a buzzer when the time set has elapsed.



Defrost by weight

This function defrosts foods on the basis of the type and weight of the frozen product.



Defrost by time

This function allows you to defrost food on the basis of a selectable time.



Proving

The proving function, using the heat coming from the top, makes it possible to prove all types of dough, guaranteeing perfect results quickly.



Food warming

To heat food or keep it hot.



Sabbath mode

This function allows food to be cooked in accordance with the provisions of the Jewish religion day of rest.



ECO pyrolytic

When this function is set, the oven carries out a pyrolytic cycle at 500°C for a pre-set time. For use in the case of ovens which are not too dirty.



Pyrolytic

When this function is set, the appliance reaches temperatures of up to 500°C, destroying all the grease which forms on the internal walls.



The more complex special functions will be described below. For the **ECO Pyrolytic** and **Pyrolytic** functions see "4 Cleaning and maintenance".



Use

Timer

1. Turn the control knob to the right or left to select **timer** from the “special functions” menu.
2. Press the control knob to confirm.

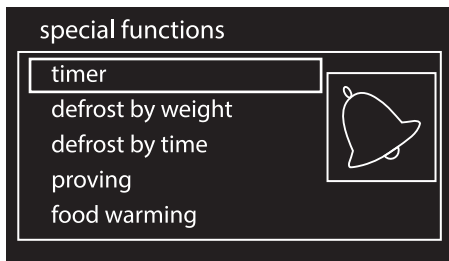

3. Turn the control knob right or left to set the duration (from 1 minute to 4 hours). After a few seconds, the  symbol stops flashing and the countdown starts.



4. If you leave the timer setting screen, the  symbol will be displayed at the top left, indicating that a timer is active.

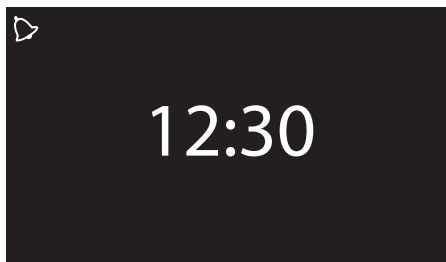

You must return the counter to zero to remove the special timer.



If a function is activated after setting a minute minder time, this time will be automatically used as a timer for the function, except for some special functions, automatic programs and personal recipes.



This function only activates the buzzer, without stopping cooking.



Defrost by weight

1. Place the food inside the appliance.
2. Turn the control knob to the right or left to select **defrost by weight** from the "special functions" menu.
3. Press the control knob to confirm.

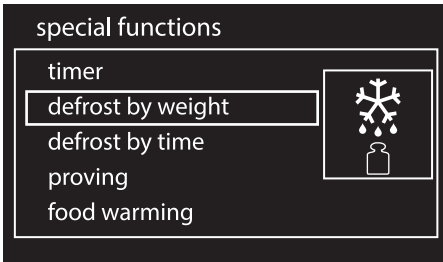

4. Turn the control knob to select the type of food to defrost.

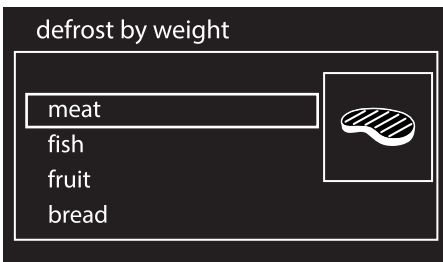

5. Turn the control knob to select the weight (in kilograms) of the food to defrost.



6. Press the control knob to confirm the set parameters.

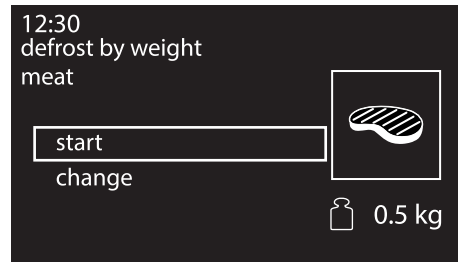

7. Press the control knob again to start defrosting, or select change to further modify the set parameters.





Use

- When finished, "function ended" appears on the display and a buzzer sounds.
- To turn off the buzzer, press or turn one of the two knobs or open the door.

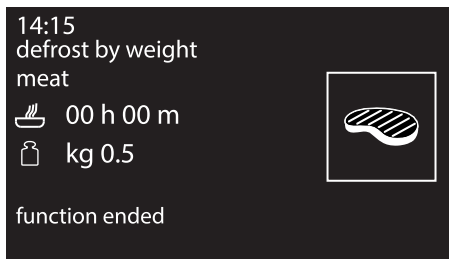

Pre-set parameters:

Type	Weight (g)	Time (default)
Meat	0.1 to 1.1 (default 0.5)	02h 00m
Fish	0.1 to 0.7 (default 0.3)	00h 55m
Fruit	0.1 to 0.5 (default 0.3)	00h 35m
Bread	0.1 to 0.5 (default 0.3)	00h 25m

*Defrosting times can vary according to the shape and size of the food to be defrosted.

Defrost by time

- Place the food inside the appliance.
- Turn the control knob to the right or left to select **defrost by time** from the "special functions" menu.
- Press the control knob to confirm.

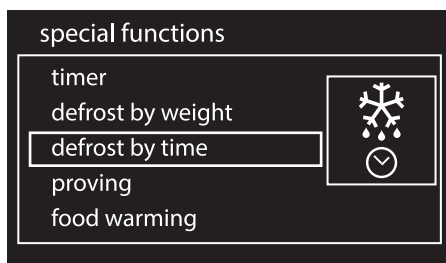

- Turn the control knob to adjust the value (from 1 minute to 13 hours).

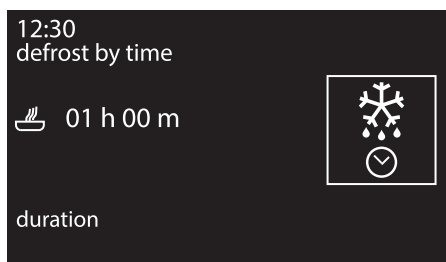



5. Press the control knob to confirm the set parameters.

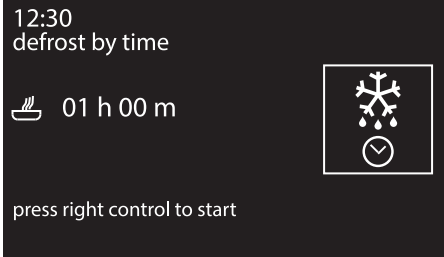

6. Press it again to start defrosting.
7. While the function is in progress, it is possible to further modify the defrosting duration. Turn the control knob to the right or left to make the required changes.
8. Press the control knob to confirm the new defrosting duration set. In any event, the defrosting will automatically resume 5 seconds from the last modification.
9. When finished, "function ended" appears on the display and a buzzer sounds.
10. To turn off the buzzer, press or turn one of the two knobs or open the door.



Proving

i For successful proving, a container of water should be placed at the bottom of the oven cavity.

1. Position the dough to prove on the second level.
2. Turn the control knob to the right or left to select **proving** from the "special functions" menu.
3. Press the control knob to confirm.

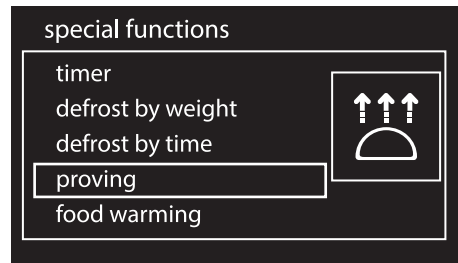

4. Press the control knob to start the function.

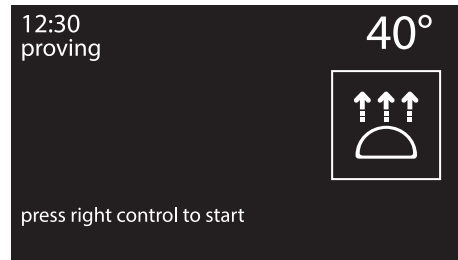



Use

5. The appliance will begin preheating.

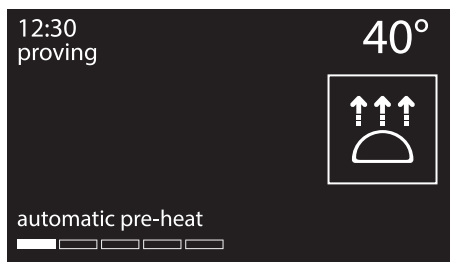

6. It will then proceed with the selected function.

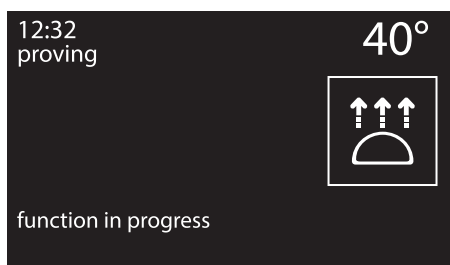

While the function is in progress, it is possible to set a timer for a maximum of 4 hours (see "Timer during a function"), a proving duration (see "Timed cooking") or delayed proving (see "Programmed cooking").

7. Press the control knob to make the required changes.

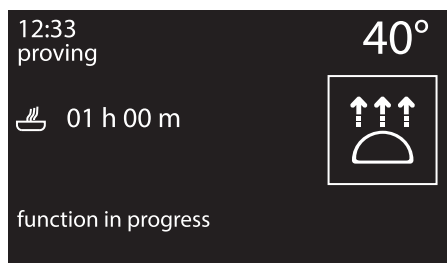

i Unless otherwise set, the proving will have a maximum duration of 13 hours.

i The light inside the oven will remain off during the proving function.

8. When finished, "function ended" appears on the display and a buzzer sounds.

9. To turn off the buzzer, press or turn one of the two knobs or open the door.

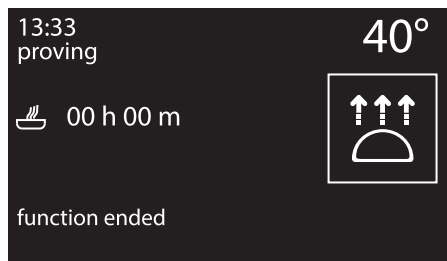

i It is not possible to modify the temperature of the proving function.



Food warming

1. Put the tray on the first shelf and place the plates to be warmed on it.

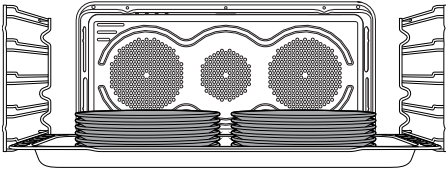

Do not stack plates too high. Stack plates no more than 5/6 high in a maximum of two rows.

2. Turn the control knob to the right or left to select **food warming** from the "special functions" menu.
3. Press the control knob to confirm.

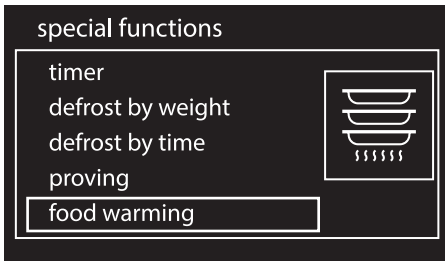

4. Press the control knob to activate the function, or turn it to adjust the pre-set temperature (from 40° to 80°).



5. The appliance will begin preheating.



EN



Use

6. It will then proceed with the selected function.

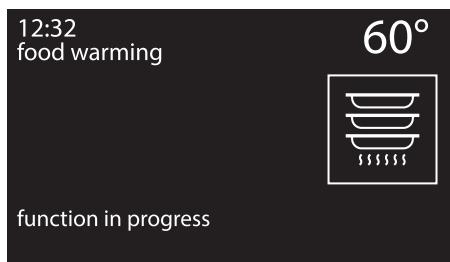

While the function is in progress, it is possible to set a timer for a maximum of 4 hours (see "Timer during a function"), a warming duration (see "Timed cooking") or a delayed warming (see "Programmed cooking").

7. Press the control knob to make the required changes.



8. When finished, "function ended" appears on the display and a buzzer sounds.
9. To turn off the buzzer, press or turn one of the two knobs or open the door.

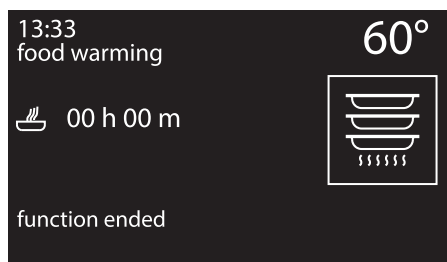

It is not possible to modify the temperature of the food warming function.



Sabbath mode



This function results in the appliance operating in a particular way:

- Cooking can proceed indefinitely, it is not possible to set any cooking duration.
- No preheating will be performed.
- The cooking temperature which can be selected varies between 60-100 °C.
- The oven light remains turned off, any attempt to turn it on by opening the door or manually turning on the oven using the control knob does not turn the light on.
- The internal fan remains turned off.
- Knob lights and buzzers disabled.



After activating the Sabbath mode the settings cannot be altered.

Any action on the knobs will produce no effect; only the control knob remains active to allow you to return to the main menu.

1. Turn the control knob to the right or left to select **sabbath mode** from the "special functions" menu.

2. Press the control knob to confirm.

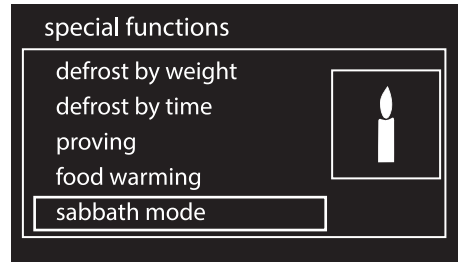

3. Turn the control knob to the right or left to change the heating temperature.

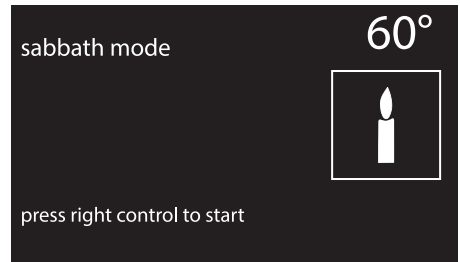

4. Press the control knob to start the Sabbath mode.

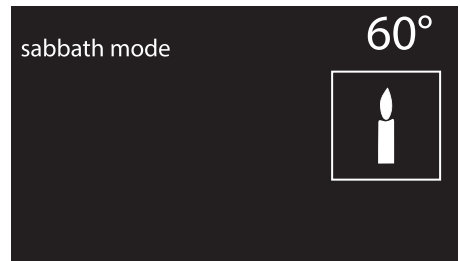

5. When finished, press and hold the control knob for at least 5 seconds to return to the main menu.



3.7 Preset programs

i This mode allows you to select a previously stored program for cooking food. The appliance will automatically calculate the optimum cooking parameters according to the weight selected.

1. On the clock screen, press the control knob to access the main menu.
2. Turn the control knob to the right or left to select **preset programs** from the “main” menu.
3. Press the control knob to confirm.

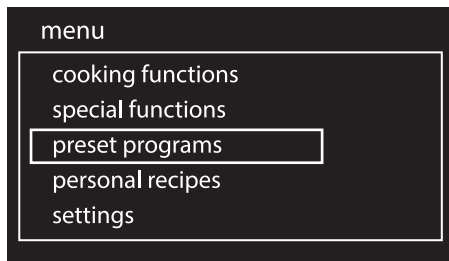

Starting a program

1. Turn the control knob to the right or left to select the required type of dish from the “preset programs” menu.
2. Press the control knob to confirm.

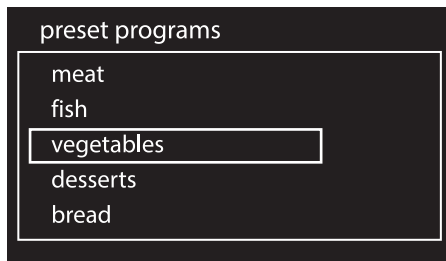

3. Select the sub-category of food to be cooked and press the control knob to confirm.





4. Select the type of cooking (where possible, depending on the dish chosen) and press the control knob to confirm.



5. Turn the control knob to select the dish weight.

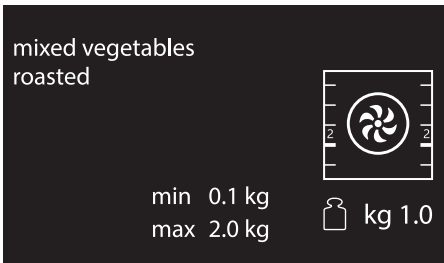

It is now possible to start the selected program, permanently modify the settings, or use the delayed cooking function.

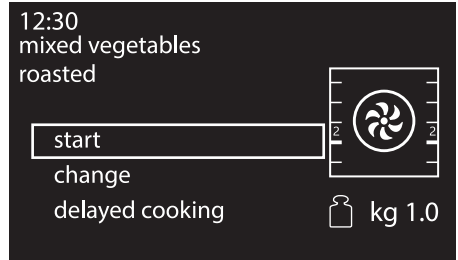

6. If you select the **start** option, cooking will start using the default program settings and all the set parameters will be shown on the display.

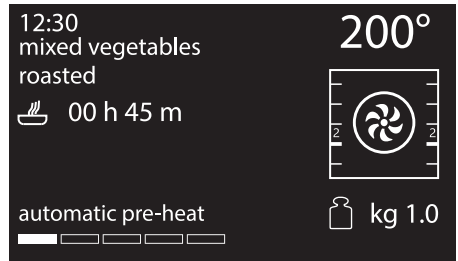

The time indicated does not include the time required to reach the set temperature.



Some of the predefined cooking parameters can be changed at any time, even after cooking has started.



Use

7. A message will indicate when to place the food in the oven and enable the start of cooking.

12:40
mixed vegetables
roasted

00 h 45 m

200°

put the food in the oven
and press the right control

kg 1.0

8. Press the control knob to start cooking.

12:41
mixed vegetables
roasted

00 h 44 m

200°

cooking in progress

kg 1.0

End of program

1. When the preset program has finished, the appliance will warn the user with buzzers and the symbol flashing.

13:25
mixed vegetables
roasted

00 h 00 m

200°

cooking completed

kg 1.0

2. Press the control knob to perform cooking with the same parameters set (press the knob twice if the buzzer is active). The appliance will restart cooking automatically if it is still at the correct temperature, otherwise it will also restart the preheating stage.

Cooking dishes one after another is useful when cooking dishes of the same type. For example, when baking pizzas in succession.

It is not recommended to put the dish in the oven whilst the oven is warming up. Wait for the appropriate message to appear.

3. Press the return knob to exit and end the preset program.



Making permanent changes to a program

1. Inside the selected preset program, turn the control knob to the left or right to select **change** from the menu of the selected dish.
2. Press the control knob to confirm.

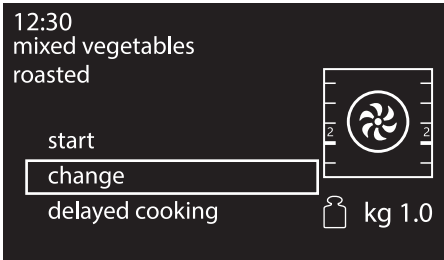

3. Turn the control knob to the right or left to select the **function** to associate with the preset program.

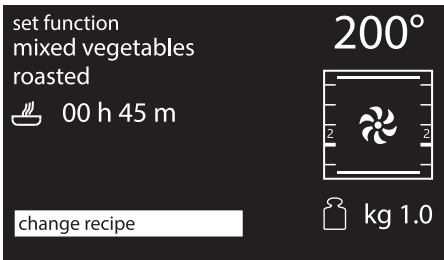

4. Press the control knob to confirm.

5. Turn the control knob to the right or left to select the **weight** to associate with the preset program.

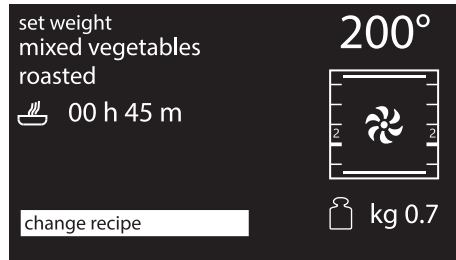

6. Press the control knob to confirm.
7. Turn the control knob to the right or left to select the **duration** to associate with the preset program.



8. Press the control knob to confirm.



Use

9. Turn the control knob to the right or left to select the **temperature** to associate with the preset program.

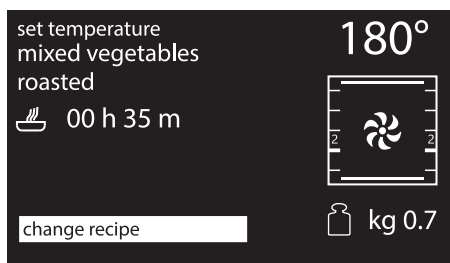

10. Press the control knob to confirm.

11. Turn the control knob to the right or left to select the **shelf** to associate with the preset program.



12. Press the control knob to confirm.

13. Pressing the control knob again will return to point 2 of the change sequence. You must press the return knob to save the preset program. You will be prompted to confirm the changes you have just made.

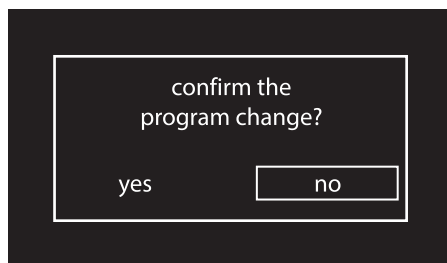

i If you do not confirm the changes the program will remain unchanged.

14. If the changes are confirmed the display will show confirmation of this.

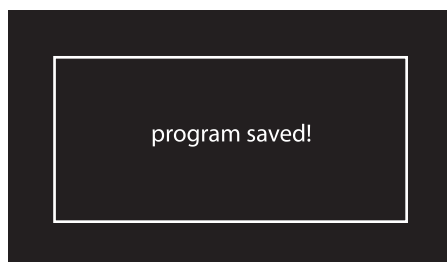



Preset program table

MEAT







Subcategory	Cooking	Weight (Kg)	Level	Function	Temp. (°C)	Time (minutes)
Roast beef	rare	1.3	2		200	49
	medium	1.3	2		200	56
	well done	1.4	2		200	70
Pork loin	-	0.8	2		190	88
Lamb	medium	2	2		190	105
	well done	2.1	2		190	130
Veal	-	1	2		190	80
Pork spare ribs	-	1	4		250	10 + 6 ⁽¹⁾
Pork chops	-	1.3	4		280	14 + 4 ⁽¹⁾
Pork sausages	-	1	4		280	7 + 5 ⁽¹⁾
Bacon	-	0.4	4		250	4 + 2 ⁽¹⁾
Turkey	roasted	2.3	2		190	115
Chicken	roasted	1	2		200	80
Rabbit	roasted	0.9	2		190	75

⁽¹⁾ When you grill food, it is recommended to cook it on both sides referring to the times indicated in the table. The longer length of time indicated always refers to the first side to be cooked starting from the uncooked food.







Use

FISH

Subcategory	Cooking	Weight (Kg)	Level	Function	Temp. (°C)	Time (minutes)
Fresh fish	-	0.5	2		160	35
Frozen fish	-	0.6	2		160	50
Firm fish	-	1	2		160	50
Delicate fish	-	0.5	2		160	57
Snapper	-	1.2	2		180	65
Flounder	-	1	2		160	40

VEGETABLES

Subcategory	Cooking	Weight (Kg)	Level	Function	Temp. (°C)	Time (minutes)
Mixed vegetables	grilled	0.5	4		250	15 + 8 ⁽¹⁾
	roasted	1	2		200	33
Potatoes	roasted	1	2		200	30
	frozen	0.5	2		220	18

⁽¹⁾ When you grill food, it is recommended to cook it on both sides referring to the times indicated in the table. The longer length of time indicated always refers to the first side to be cooked starting from the uncooked food.



DESSERTS/PASTRIES

Subcategory	Cooking	Weight (Kg)	Level	Function	Temp. (°C)	Time (minutes)
Ring cake	-	1.5	2		160	50
Biscuits	-	0.5	2		160	23
Muffins	-	0.5	2		160	21
Profiteroles	-	0.5	2		180	70
Meringues	-	0.4	2		130	93
Sponge cake	-	1	2		150	60
Strudel	-	0.8	2		170	45
Tarts	-	1	2		170	43
Brioche bread	-	0.9	2		180	39
Croissants	-	0.5	2		160	35

BREAD

Subcategory	Cooking	Weight (Kg)	Level	Function	Temp. (°C)	Time (minutes)
Leavened bread	-	0.8	2		200	27
Focaccia	-	1	2		180	20
Pan baked pizza	-	0.9	2		280	12



Use





PIZZA

Subcategory	Cooking	Weight (Kg)	Level	Function	Temp. (°C)	Time (minutes)
Stone baked pizza	fresh	0.7	1 ⁽²⁾		280	7
	frozen	0.2	1 ⁽²⁾ (3)		230	4

⁽²⁾ The stone must be placed on the bottom of the oven cavity.

⁽³⁾ Frozen pizzas of different weights cooked on the stone do not require different cooking times.

PASTA/RICE

Subcategory	Cooking	Weight (Kg)	Level	Function	Temp. (°C)	Time (minutes)
Pasta bake	-	1.9	1		220	35
Lasagne	-	3	1		230	40
Paella	-	0.5	2		190	25
Quiche	-	1	1		200	40
Soufflé	-	0.5	2		180	25



SLOW COOKING

Subcategory	Cooking	Weight (Kg)	Level	Function	Temp. (°C)	Time (minutes)
Veal	-	1.5	2		90	540
Beef	rare	1.4	2		90	190
	well done	1	2		90	480
Pork	-	1	2		90	420
Lamb	-	1.5	2		90	480

EN



The cooking times in the tables refer to the food indicated in the recipe. They are a guide only and may vary depending on personal taste.



The tables give the factory-set data. To reset a preset program with the original settings after it has been changed permanently, just enter the data given in the table above.



If ECO logic mode (see 3.9 Settings) has been activated, cooking times or preheating times may vary.



3.8 Personal recipes

i This menu allows you to enter a personal recipe with the parameters you wish to use. On first use, the appliance will only offer you to add a new recipe. After storing your personal recipes, they will be available in the relative menu.

1. On the clock screen, press the control knob to access the main menu.
2. Turn the control knob to the right or left to select **personal recipes** from the main menu.
3. Press the control knob to confirm.

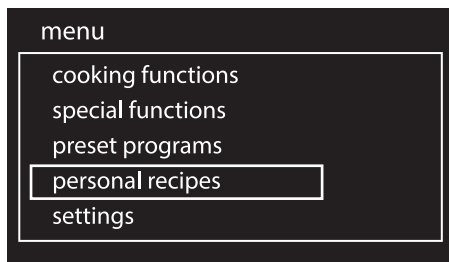

i It is possible to store around 10 personal recipes.

Adding a recipe

1. Select **add** from the “personal recipes” menu.

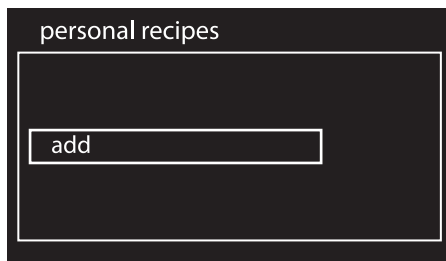

2. Turn the control knob to the right or left to select the **function** to associate with the recipe.





3. Press the control knob to confirm.
4. Turn the control knob to the right or left to select the **weight** to associate with the recipe.



5. Press the control knob to confirm.



The weight can be set or modified up to 5 kg, but the user is responsible for ensuring that the dish will fit inside the oven.

6. Turn the control knob to the right or left to select the **duration** to associate with the recipe.



7. Press the control knob to confirm.
8. Turn the control knob to the right or left to select the **temperature** to associate with the recipe.

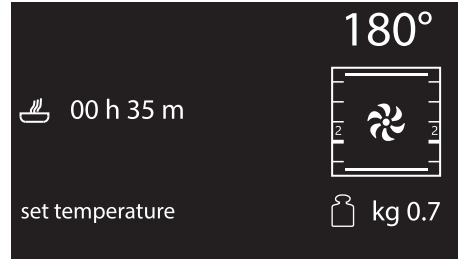

9. Press the control knob to confirm.
10. Turn the control knob to the right or left to select the **shelf** to associate with the recipe.

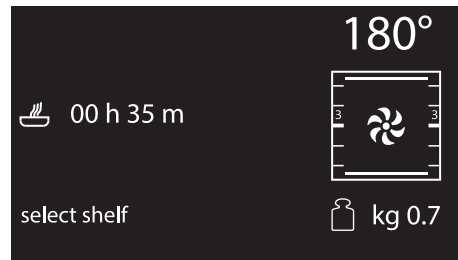



11. Press the control knob to confirm.

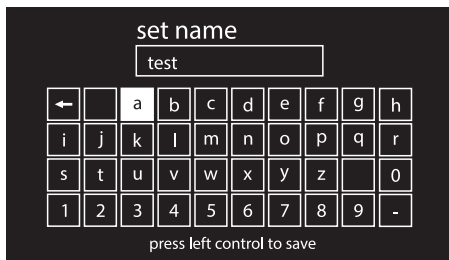

Use

12. Pressing the control knob again will return to point 2 of the change sequence. You must press the return knob to save the recipe. The appliance will ask you to enter a name for the recipe you have just created.



13. Enter the name of the recipe. Turn the control knob to select the character to enter. Each time the control knob is pressed, a character of the name will be entered. The character  deletes the previous letter.

i The name of the recipe can contain a maximum 10 characters, including spaces.

i The name must contain at least one character in order to store the recipe.

14. After entering the name of your recipe, press the return knob to confirm or cancel the information you have entered. Select **YES** if you wish to store the recipe.

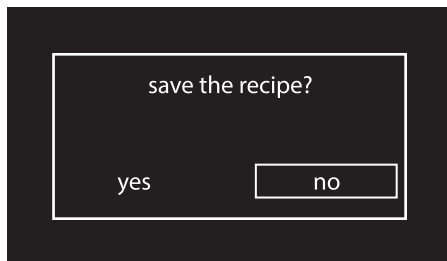

i If you select "NO", you will lose all changes made.

15. If the changes are confirmed the display will show confirmation of this.

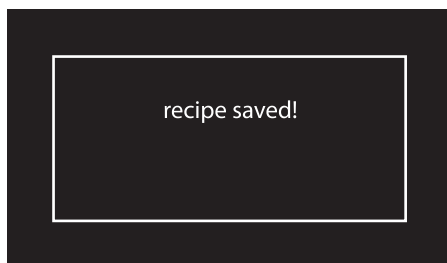



Using a personal recipe

1. Turn the control knob to the right or left to select a previously stored **personal recipe** from the "personal recipes" menu (in the example, the recipe **test** has been stored).



2. Press the control knob to confirm.
3. Turn the control knob to the right or left to select **start**.

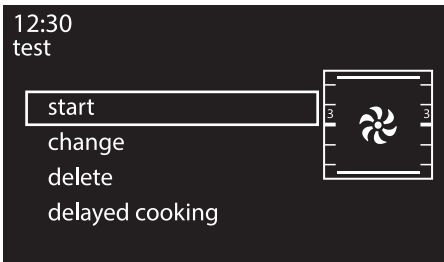

4. Press the control knob to confirm.

Cooking will start with the parameters that were previously set for the recipe.

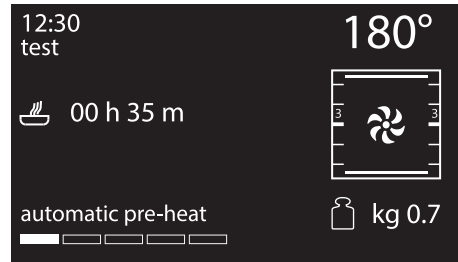

During cooking it is always possible to modify the temperature and cooking time, but this will not be saved to the recipe for future use.



Changing a personal recipe

1. Turn the control knob to the right or left to select a previously stored **personal recipe** from the “personal recipes” menu (in the example, the recipe **test** has been stored).

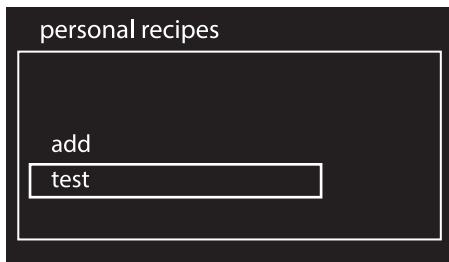

2. Press the control knob to confirm.
3. Turn the control knob to the right or left to select **change**.

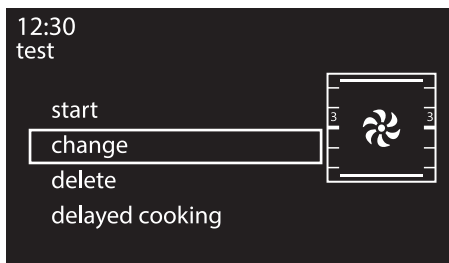

4. Press the control knob to confirm.
5. Repeat the same steps starting from point 2 in chapter “Adding a recipe”.

Deleting a personal recipe

1. Turn the control knob to the right or left to select a previously stored **personal recipe** from the “personal recipes” menu (in the example, the recipe **test** has been stored).

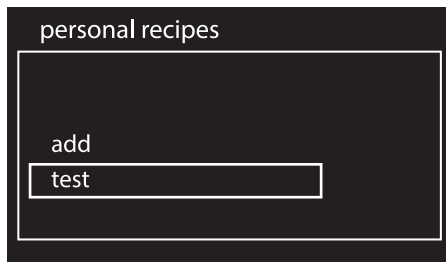

2. Press the control knob to confirm.
3. Turn the control knob to the right or left to select **delete**.

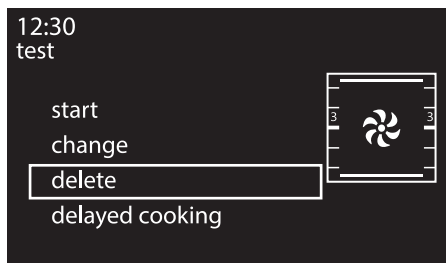

4. Press the control knob to confirm.



5. Confirm the deletion. Select YES to delete the recipe permanently.



6. If you confirm the deletion, the display will show a confirmation message.



Delayed cooking

1. Turn the control knob to the right or left to select a previously stored **personal recipe** from the "personal recipes" menu (in the example, the recipe **test** has been stored).

NE



2. Press the control knob to confirm.
3. Turn the control knob to the right or left to select **delayed cooking**.



4. Press the control knob to confirm.



Use

- Turn the control knob to the right or left to select the cooking end time with the control knob. The  symbol flashes.

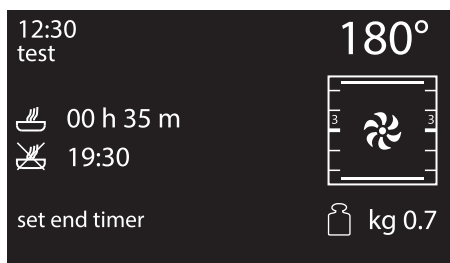

- Press the control knob to confirm.

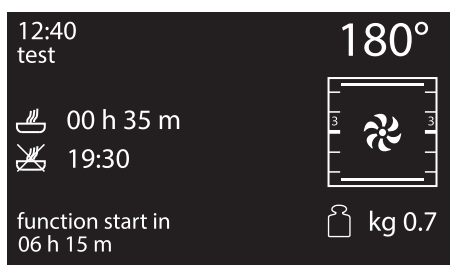

After a few seconds the  symbol stops flashing. The appliance waits for the delay start time.

3.9 Settings



The product's configuration can be set using this menu.

- On the clock screen, press the control knob to access the main menu.
- Turn the control knob to the right or left to select **settings** from the main menu.
- Press the control knob to confirm.

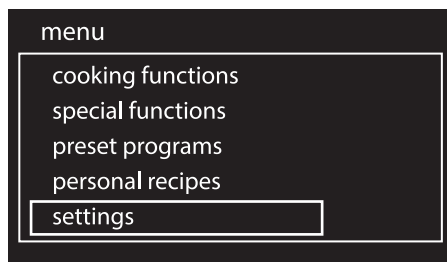



Language

Sets the interface language from those available.

1. Turn the control knob to the right or left to select **language** from the “settings” menu.

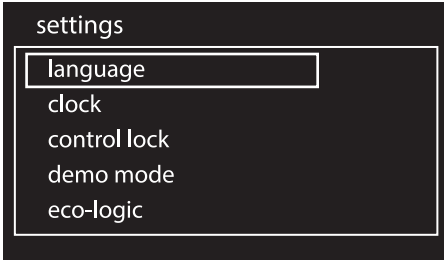

2. Press the control knob to confirm.
3. Turn the control knob to the right or left to select the required language.

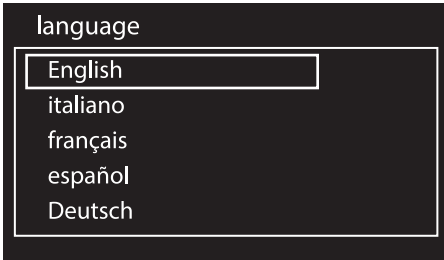

4. Press the control knob to confirm the selected language.

Clock

Sets the time displayed.

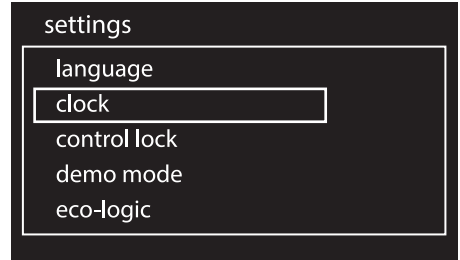

1. Turn the control knob right or left to set the hour.
2. Press the control knob to move to changing the minutes.
3. Turn the control knob right or left to set the minutes.

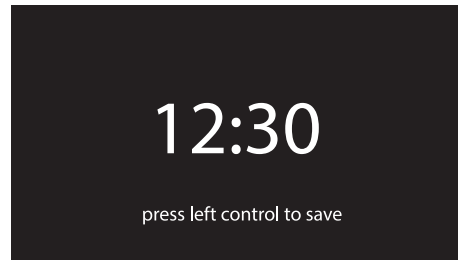

4. Press the return knob to confirm.



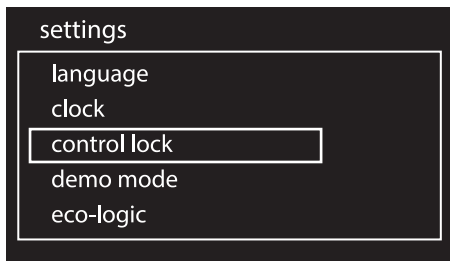

Control lock

Allows the appliance to automatically lock the controls after one minute of normal operation without any intervention from the user.

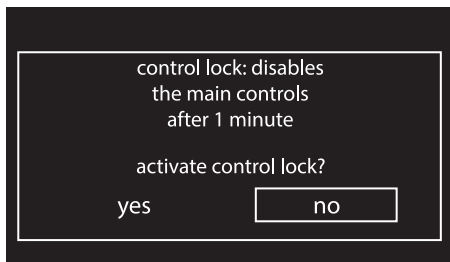

- To confirm that you wish to activate the control lock, select **YES**.



During normal operation, it is indicated by the  indicator light coming on.

- To release the lock temporarily during cooking, hold the return knob down for 3 seconds. One minute after the last setting the lock will become active again.



Touching or varying the position of the control and return knobs, the display will show a warning for two seconds.

Demo mode (for showrooms only)

This mode allows the appliance to deactivate all heating elements, while keeping the control panel active.

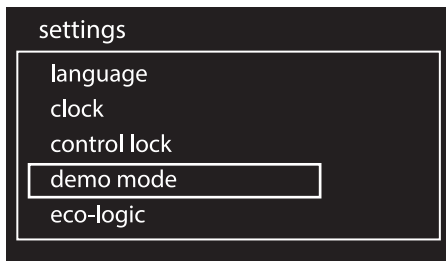

- To confirm the activation of the demo mode, select **YES**.

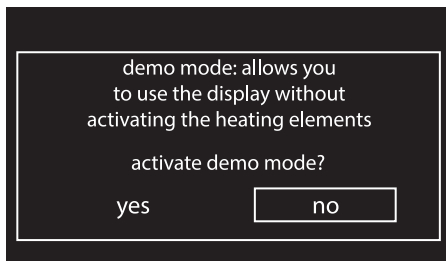

 If the mode is active, "demo mode" will be shown on the display.

 To use the appliance normally, set this mode to **OFF**.



Eco-Logic (on some models only)

This mode allows the appliance to limit the power used. Suitable for simultaneous use with further home appliances.

If this option is enabled, the  symbol will appear on the display.

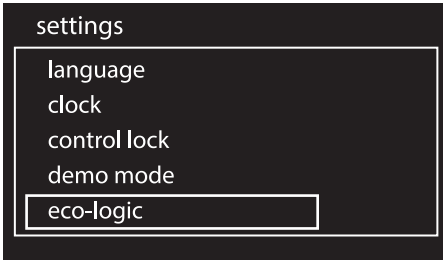

- To confirm the activation of the eco-logic mode, select YES.

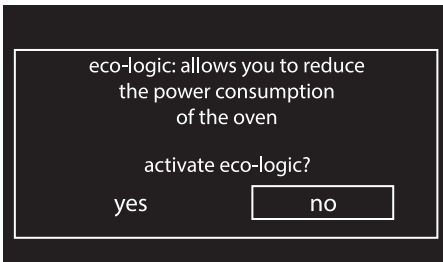

When eco-logic mode is active, preheating and cooking times may be extended.

Sound

Whenever one of the knobs is pressed, the appliance beeps. This setting disables these sounds.

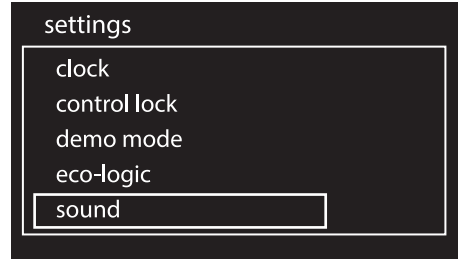

- To disable sounds when the knobs are pressed, select NO.

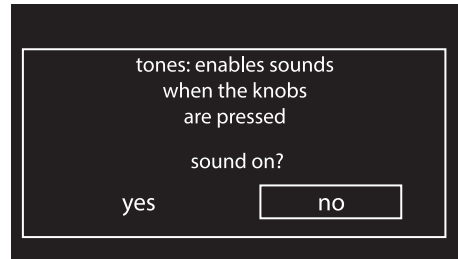



Keep warm

This mode allows the appliance to keep cooked food warm (at low temperatures) after cooking finishes with a cooking cycle for which a duration has been set (if this is not manually interrupted), without altering the taste and aromas obtained during cooking.

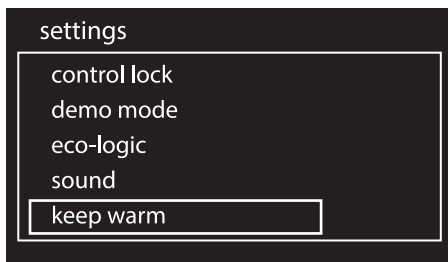

- To confirm the activation of the keep warm mode, select YES.



Eco-Light

For greater energy savings, the light is turned off automatically one minute after the start of cooking.

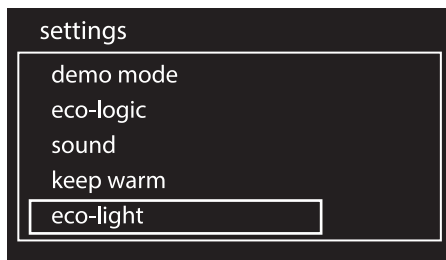

- To confirm that you wish to activate the Eco-Light mode, select YES.

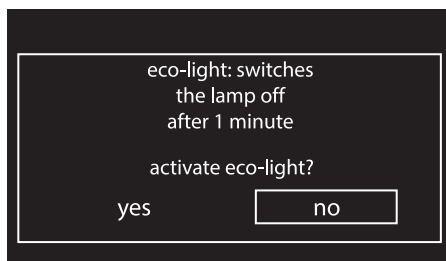

- To prevent the appliance from turning off the light automatically after one minute, set this mode to OFF.



If the Eco-Light function is set to OFF, the appliance is in standby and displays the current time dimly.



If the Eco-Light function is set to OFF, the appliance consumes more energy when it is in standby mode.



The manual off/on control is always available with both settings by turning the return knob to the right.



The Eco-Light mode also turns off the display after 2 minutes of inactivity.

Digital clock

Displays the time in digital format.

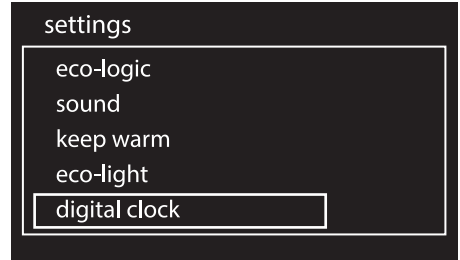

- To confirm the activation of the digital clock, select YES.

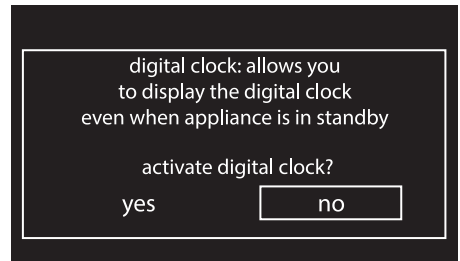

When no appliance function is active, the display will show the current time in digital format.

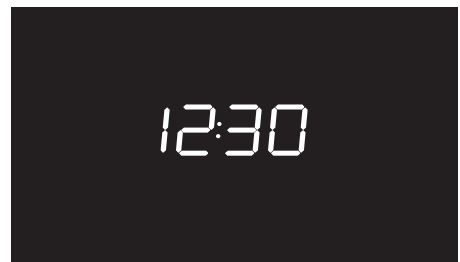



4 Cleaning and maintenance

4.1 Instructions



Improper use

Risk of damage to surfaces

- Do not use steam jets to clean the appliance.
- Do not use cleaning products containing chlorine, ammonia or bleach on steel parts or parts with metallic surface finishes (e.g. anodizing, nickel- or chromium-plating).
- Do not use abrasive or corrosive detergents (e.g. scouring powders, stain removers and metallic sponges) on glass parts.
- Do not use rough or abrasive materials or sharp metal scrapers.



We recommend the use of cleaning products distributed by the manufacturer.

4.2 Cleaning the surfaces

To keep the surfaces in good condition, they should be cleaned regularly after use. Let them cool first.

Ordinary daily cleaning

Always use only specific products that do not contain abrasives or chlorine-based acids.

Pour the product onto a damp cloth and wipe the surface, rinse thoroughly and dry with a soft cloth or a microfibre cloth.

Food stains or residues

Do not use steel sponges or sharp scrapers as they will damage the surfaces.

Use ordinary non-abrasive products with the aid of wooden or plastic utensils if necessary. Rinse thoroughly and dry with a soft cloth or a microfibre cloth.

Do not allow residues of sugary foods (such as jam) to set inside the oven. If left to set for too long, they might damage the enamel lining of the oven.



4.3 Cleaning the door

Removing the door

For easier cleaning, it is recommended to remove the door and to place it on a tea towel.

To remove the door proceed as follows:

1. Open the door completely and insert two pins into the holes on the hinges indicated in the figure.

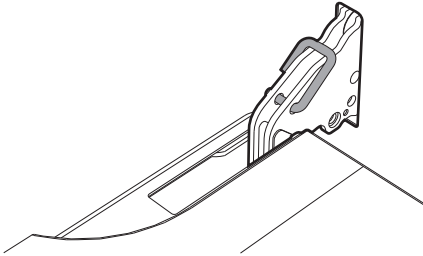

2. Grasp the door on both sides with both hands, raise it so that it forms an angle of around 30° and remove it.

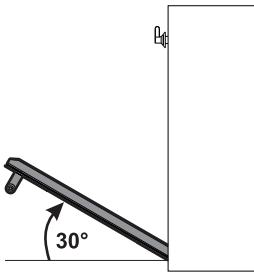

3. To reassemble the door, put the hinges in the relevant slots in the oven, making sure that grooved sections **A** are resting completely in the slots. Lower the door and once it is in place remove the pins from the holes in the hinges.

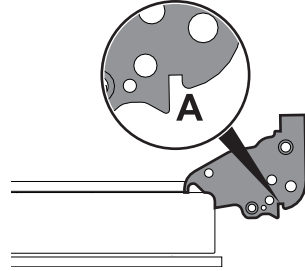

Cleaning the door glazing

The glass in the door should always be kept thoroughly clean. Use absorbent kitchen roll. In case of stubborn dirt, wash with a damp sponge and an ordinary detergent.



We recommend the use of cleaning products distributed by the manufacturer.



Cleaning and maintenance

Removing the internal glass panels

For easier cleaning, the internal glass panels of the door can be removed.

1. Open the door.
2. Insert the locking hooks into the holes on the hinges to prevent the door from being closed by accident.
3. Pull the rear part of the internal glass panel gently upwards, following the movement indicated by the arrows (1).

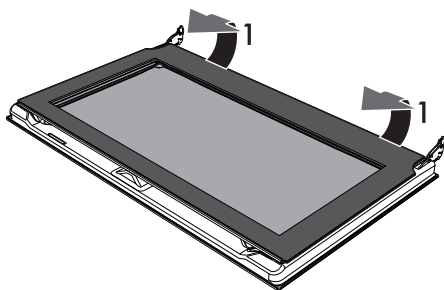

4. Remove the internal glass panel from the front strip (2) to remove it from the door.

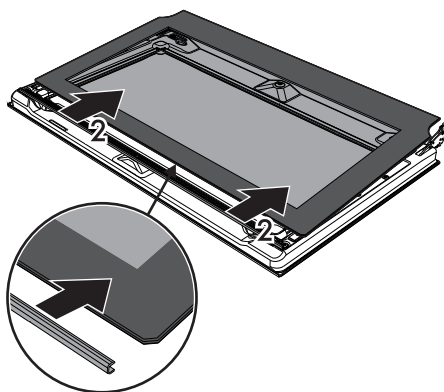

5. Remove the intermediate glass panels by lifting them upwards.

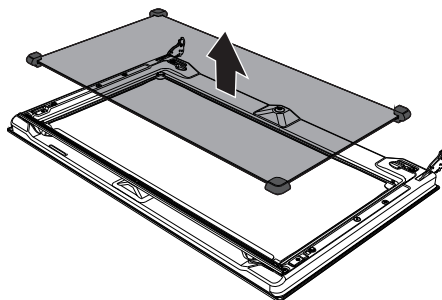

6. Clean the external glass panel and the panels removed previously. Use absorbent kitchen roll. In case of stubborn dirt, wash with a damp sponge and neutral detergent.

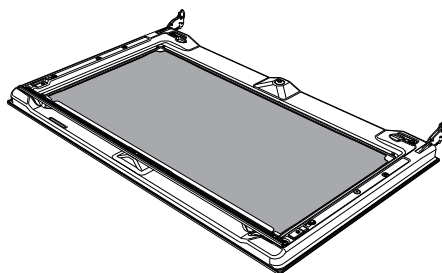

7. When you have finished cleaning, replace the intermediate glass panel into the housing on the door.
8. Reposition the internal glass panel, place the upper part into the strip on the door and insert the 2 rear pins into their housings on the oven door by applying slight pressure.



4.4 Cleaning the oven

In order to keep your oven in the best possible condition, clean it regularly after letting it cool down.

Do not allow food residues to dry inside the oven cavity because doing so could damage the enamel.

Before cleaning, remove all the parts that can be removed.

For easier cleaning, it is recommended to remove:

- The door
- The rack/tray support frames
- The oven seal.



If you use specific oven cleaning products, it is recommended to operate the appliance at maximum temperature for about 15-20 minutes afterwards in order to burn off any residues.

Removing rack/tray support frames

Removing the rack/tray support frames enables the sides to be cleaned more easily.

Removing the rack/tray support frames:

- Pull the frame towards the inside of the oven cavity to unhook it from its groove **A**, then slide it out of the seats **B** at the back.

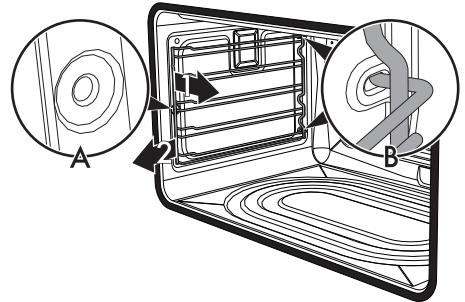

- After cleaning, repeat the above procedures to replace the rack/tray support frames.



Cleaning and maintenance

4.5 Pyrolytic



The pyrolytic function consists of an automatic high-temperature cleaning procedure which causes dirt to dissolve. Thanks to this process, it is possible to clean the oven cavity very easily.



Improper use Risk of damage to surfaces

- Remove any food residues or large spills from previous cooking operations from the oven cavity.
- Switch off the burners or the electric hot plates of the cooktop if installed above the appliance.

Preliminary operations

Before starting the pyrolytic cycle:

- Clean the internal glass panel following the usual cleaning instructions.
- For very stubborn encrustations spray an oven cleaning product onto the glass (read the warnings on the product); leave for 60 minutes, then rinse and dry the glass using kitchen roll or a microfibre cloth.

- Completely remove all accessories from inside the oven.
- Remove the rack/tray support frames.
- Remove the upper guard (if present).
- Close the door.

Pyrolytic function setting

1. Turn the control knob to the right or left to select **eco pyrolytic** or **pyrolytic** from the "special functions" menu. Then press it to confirm.

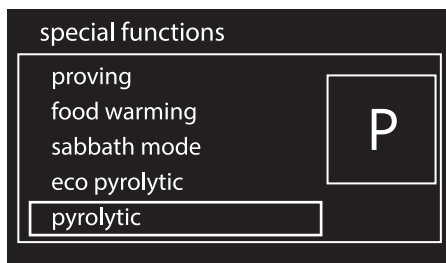
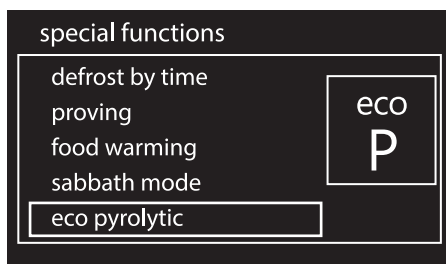



2. Turn the control knob to set the duration of the cleaning cycle from a minimum of 2 hours to a maximum of 3 hours (except for the **ECO P** function, the duration of which is set to 2 hours).

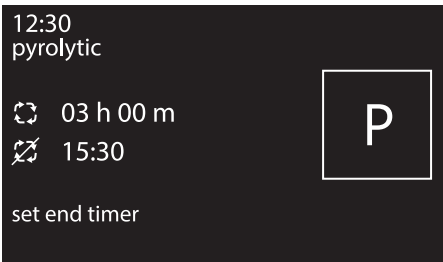
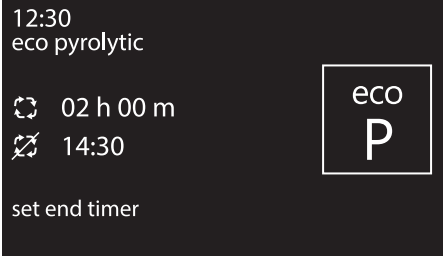

3. Press the control knob. The  symbol will now be lit solidly. The display shows a warning to remove accessories from inside the oven cavity.

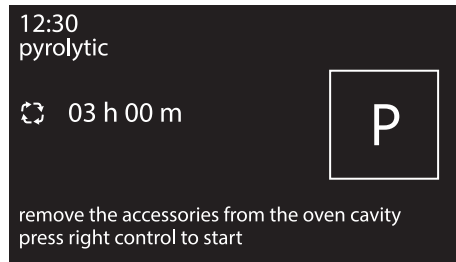
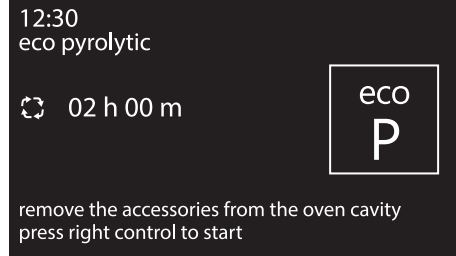

4. Press the control knob to start the pyrolytic cycle.



Recommended pyrolytic cycle duration:

- Light dirt: 2 hours.
- Medium dirt: 2 ½ hours.
- Heavy dirt: 3 hours.



Cleaning and maintenance

Pyrolytic

1. The display shows “cleaning in progress” and the remaining time to indicate that the appliance is carrying out the automatic cleaning cycle. Two minutes after the pyrolytic cycle has started the door is locked (the door lock indicator light  comes on) by a device that prevents the door from being opened.

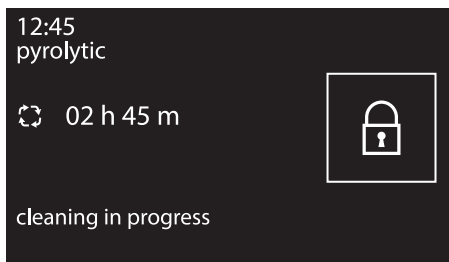
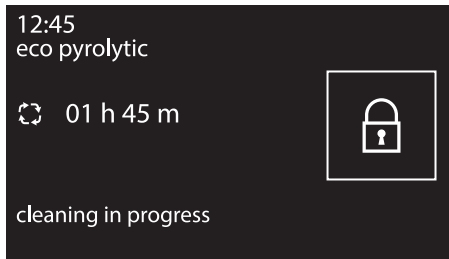

2. At the end of the pyrolytic cycle, the door remains locked until the temperature inside the oven cavity returns to a safe level.

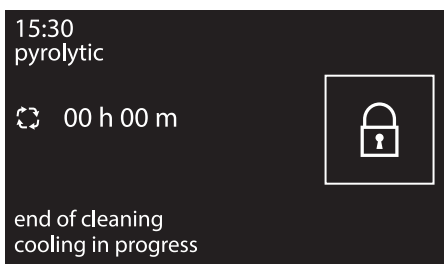
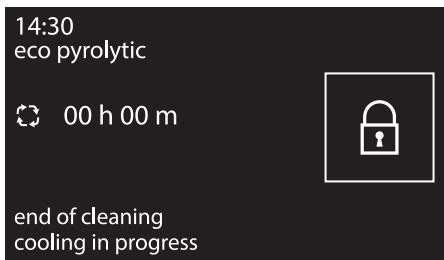

3. The display indicates that the cooling procedure inside the oven cavity is in progress.



It is not possible to select any function once the door lock device has been activated.



4. Wait for the appliance to cool down and collect the residues deposited inside using a damp microfibre cloth.



i During the first pyrolytic cycle, unpleasant odours may occur due to the normal evaporation of oily manufacturing substances. This is an absolutely normal phenomenon which disappears after the first pyrolytic cycle.

i During the pyrolytic cycle the fans produce a more intense level of noise due to a greater rotation speed. This is an absolutely normal operation, intended to provide more effective heat dispersal. At the end of the pyrolytic cycle, the fans will continue to operate for long enough to prevent the walls of adjacent units and the front of the oven from overheating.

 If the pyrolytic cycle gives unsatisfactory results at minimum duration, it is recommended to set a longer time for successive cleaning cycles.

Setting of programmed pyrolytic cycle

It is possible to program the pyrolytic cycle start time.

1. After selecting the pyrolytic cycle duration, press the control knob. The display shows the current time and the  symbol comes on.
2. Turn the control knob to set the time you wish the pyrolytic cycle to finish.
3. After a few seconds, the  and  symbols remain lit steadily and the appliance waits for the set start time before starting the cleaning cycle.

i It is not possible to select any function once the door lock device has been activated. It remains possible, however, to switch off the appliance using the specific controls.



Cleaning and maintenance

4.6 Extraordinary maintenance

Replacing the internal light bulb



Live parts

Danger of electrocution

- Unplug the appliance from the power supply.



The oven cavity is fitted with a 40W light bulb.

1. Completely remove all accessories from inside the oven.
2. Remove the rack/tray support frames.
3. Remove the bulb cover using a tool (e.g. a screwdriver).



Be careful not to scratch the enamel on the side of the oven.

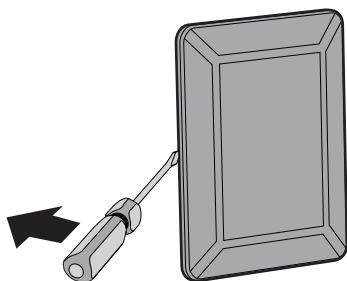

4. Slide out and remove the light bulb.

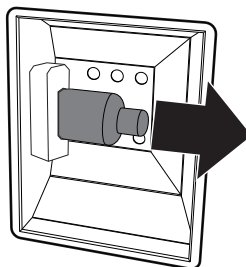

Do not touch the halogen lamp directly with your fingers, but hold it using insulating material.

5. Fit the new light bulb.
6. Replace the bulb cover. Ensure that the moulded internal part of the glass (A) is facing towards the door.

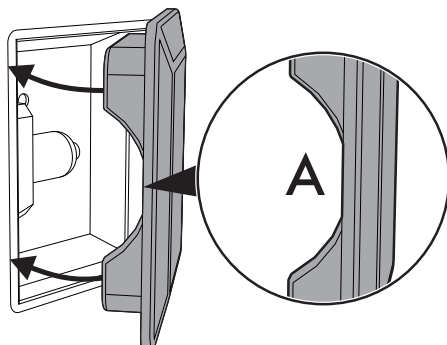

7. Press the cover completely down so that it attaches perfectly to the bulb support.



What to do if...

The display is completely off:

- Check the mains power supply.
- Check whether an omnipolar switch upstream of the appliance supply line is in the "ON" position.

The appliance does not heat up:

- Check whether it has been set in "demo" mode (for further details see "Settings").

The controls do not respond:

- Check whether it has been set to "control lock" mode (for further details see "Settings").

The cooking times are longer than those indicated in the table:

- Check whether it has been set to "eco-logic" mode (for further details see "Settings").

After the automatic (pyrolytic) cleaning cycle it is not possible to select a function:

- Verify whether the door lock has deactivated. If not, the appliance has a safety device that does not allow functions to be selected while the door lock is active. This is because the temperature in the oven cavity is still too high to allow any type of cooking.

The display shows "Error 4":

- The door lock has not properly attached to the door. This might be because the door was accidentally opened during the door lock activation. Switch the appliance off and on again, wait a few minutes before selecting a new cleaning cycle.

If the door is opened during a fan assisted function, the fan stops:

- This is not a fault. It is a normal operation of the appliance, useful when cooking foods in order to avoid excessive heat escaping. When the door is closed, the oven will return to normal operation.



If the problem has not been resolved or in the case of other types of fault, contact your local technical support centre.



If other Error XX error messages are indicated:

Note down the error message, function and set temperature and contact your local technical support centre.



Installation

5 Installation

5.1 Electrical connection



**Power voltage
Danger of electrocution**

- Have the electrical connection performed by authorised persons.
- The appliance must be connected to earth in compliance with electrical system safety standards.
- Disconnect the mains power supply.

General information

Check the mains characteristics against the data indicated on the plate.

The identification plate bearing the technical data, serial number and brand name is visibly positioned on the appliance.

Do not remove this plate for any reason.

Perform the ground connection using a wire that is 20 mm longer than the other wires.

The appliance can work in the following modes:

- **220-240 V 2 \sim**

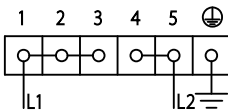

3 x 2.5 mm² three-core cable.

- **220-240 V 3 \sim**

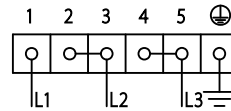

4 x 1.5 mm² four-core cable.

- **220-240 V 1N \sim**

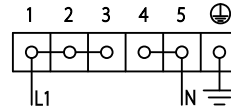

3 x 2.5 mm² three-core cable.

- **380-415 V 2N \sim**

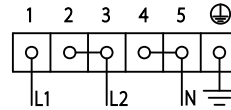

4 x 1.5 mm² four-core cable.

- **380-415 V 3N \sim**

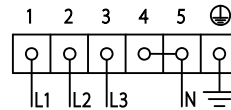

5 x 1.5 mm² five-core cable.



The values indicated above refer to the cross-section of the internal lead.



The aforementioned power cables are sized taking into account the coincidence factor (in compliance with standard EN 60335-2-6).



Fixed connection

Fit the power line with an omnipolar circuit breaker in compliance with installation regulations.

The circuit breaker should be located near the appliance and in an easily reachable position.

Connection with plug and socket

Make sure that the plug and socket are of the same type.

Avoid using adapters, gang sockets or extensions as these could cause overheating and a risk of burns.

5.2 Instructions for the installer

- The plug must be accessible after installation. Do not bend or trap the electrical power cable.
- The appliance must be installed according to the installation diagrams.
- If the appliance does not work correctly after having carried out all the checks, contact your local Authorised Service Centre.
- Once the appliance has been installed, please explain to the user how to use it correctly.

5.3 Cable replacement



**Power voltage
Danger of electrocution**

- Disconnect the mains power supply.

1. Unscrew the 4 screws on the rear casing.

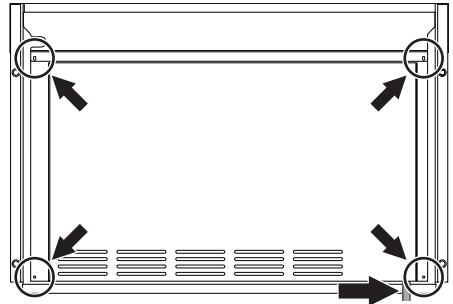

**Position of the screws and the power cable
(rear view)**

2. Lift the upper casing slightly and remove the rear casing to gain access to the terminal board.
3. Replace the cable.
4. Make sure that the cables (for the oven or any cooktop) follow the best route in order to avoid any contact with the appliance.



Installation

5.4 Positioning



**Heavy appliance
Crushing hazard**

- Position the appliance into the cabinet cutout with the help of a second person.



**Pressure on the open door
Risk of damage to the appliance**

- Never use the oven door to lever the appliance into place when fitting.
- Avoid exerting too much pressure on the oven door when open.



**Heat production during appliance operation
Risk of fire**

- Check that the piece of furniture material is heat resistant.
- Check that the piece of furniture has the required slots.
- Do not install the appliance in a recess which can be closed with a door or in a cupboard.

Fastening bushings

1. Mount the appliance into the recess.
2. Open the door completely.

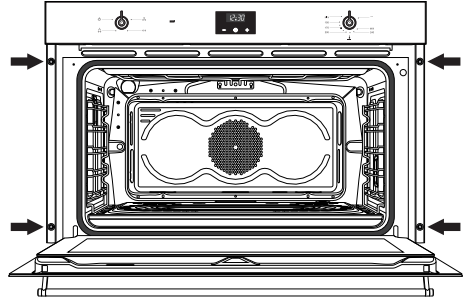

**position of covers
(front view)**

3. Remove the bushing covers from the front of the oven.

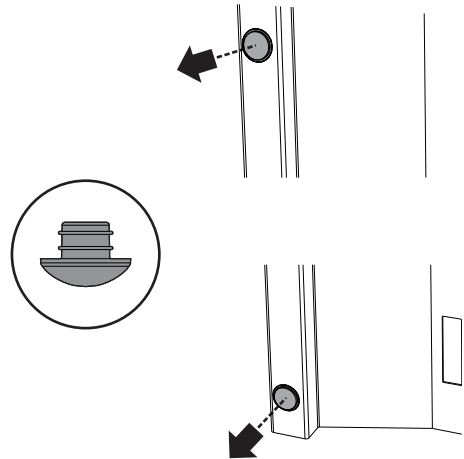



4 Secure the appliance to the piece of furniture using screws.

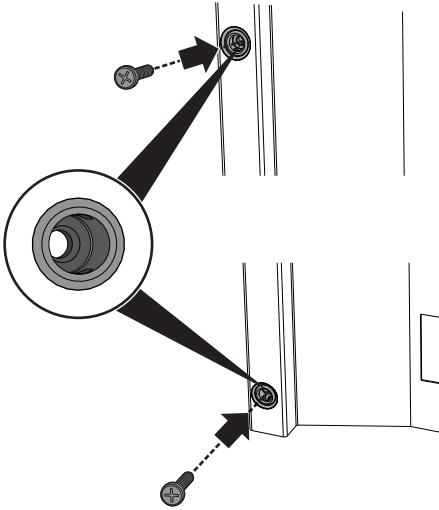

5 Cover the bushings with the previously removed covers.

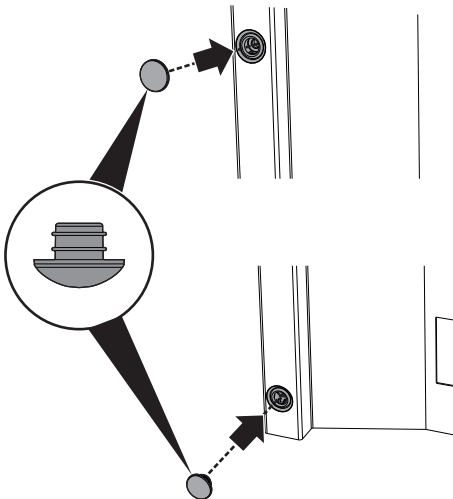

Front panel seal

When installing under a worktop, the seal provided must be glued to the back of the front panel to prevent water or other liquids leaking in from the worktop above.

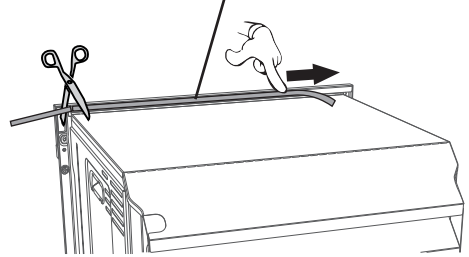

Install a wooden bar underneath the worktop.

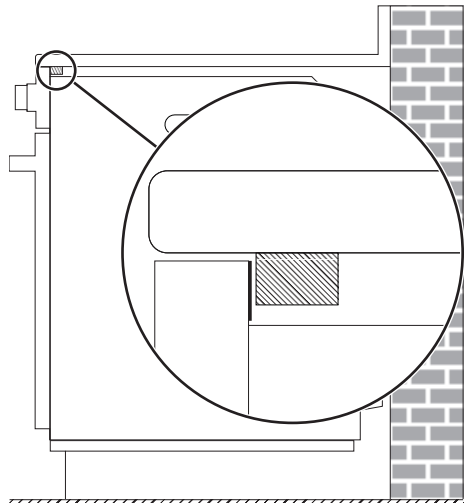

EN



Installation

Appliance overall dimensions (mm)

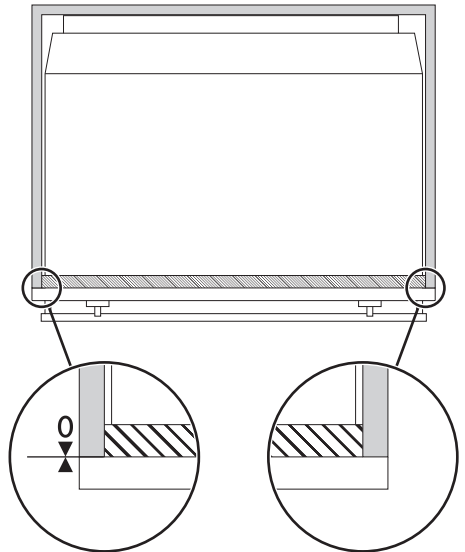
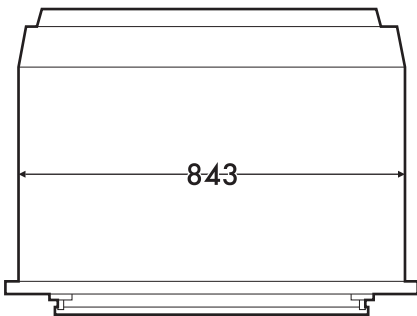
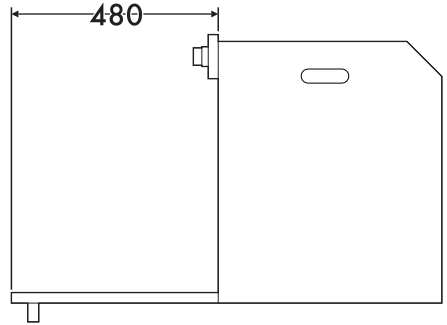
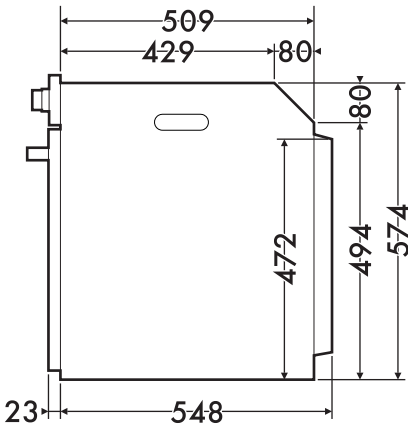
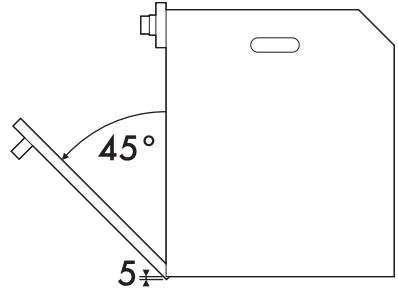
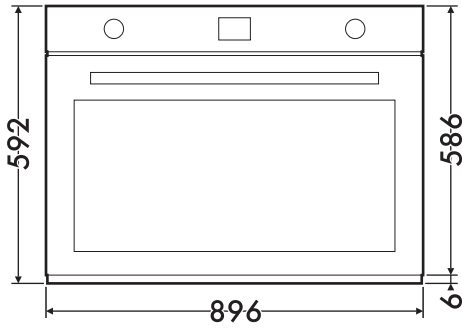



Mounting under worktops (mm)

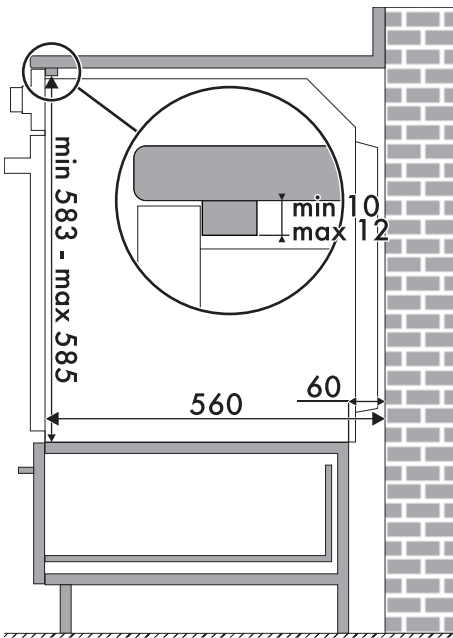
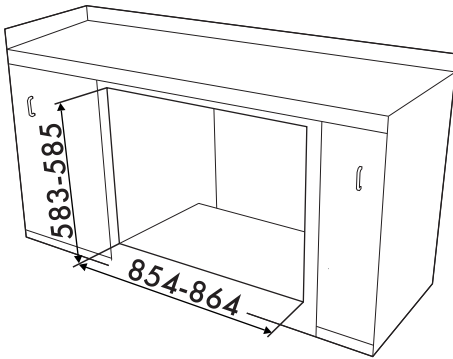

Make sure that the piece of furniture rear/bottom part has an opening of approx. 60 mm.

Mounting under cooktops

Whenever a cooktop is installed above the oven, a wooden separator has to be installed at a minimum distance of **10 mm** from the top of the oven to prevent overheating when the two appliances are used at the same time. It must only be possible to remove the separator by using suitable tools.

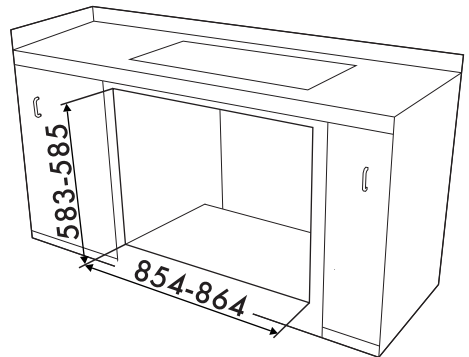
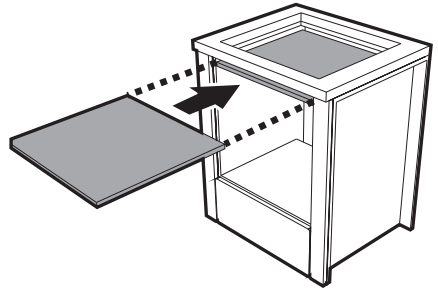



Installation

Mounting into a column (mm)

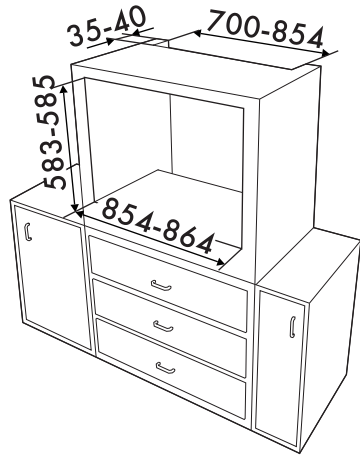
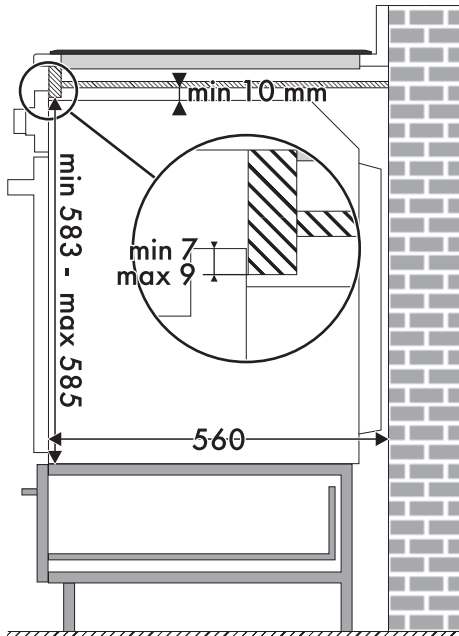

Make sure that the piece of furniture top/rear part has an opening approx. 35-40 mm deep.



When using a wooden separator, a wooden bar has to be installed under the worktop in order to use the adhesive seal that is glued to the back of the front panel to prevent water or other liquids leaking in.

